

THE CULTURE OF CONTEMPORARY RUBBER FLOORS

THE CULTURE OF CONTEMPORARY RUBBER FLOORS

PROLOGUE	5
INSPIRATIONS	15
TECHNICALS	41

Plansystem	
DHARMA	42
KAYAR	44
MULTIFLOOR / ND – UNI	46
GRANITO	48
GRAIN	50
SCREED	52
LAVA	54
NATURA	56
KAYAR / LL*	58
UNI / LL*	59
GRANITO / ANT 48*	60
GRANITO ELASTIC*	60

Studsysteem	
ZEUS / ANT 48*	61
BS	62
ZEUS	64

Stairsysteem	
FULLSTEP	66
ROLLSTEP	67

Accessories	68
Plansystem	76
Studsysteem	77

*Special

Un materiale unico per qualità tecniche e funzionali, un percorso di sperimentazione e ricerca costante, una storia aziendale alimentata ininterrottamente da quasi un secolo, tra nuove soluzioni sempre più performanti e interpretazioni estetiche in continua evoluzione.

7

La gomma è al centro di tutta la nostra attività, lo è da quando nel 1962 all'interno del Gruppo Pirelli nasce Artigo, la divisione dedicata allo sviluppo delle pavimentazioni. Nel 1992 l'acquisizione da parte del Gruppo Mondo, leader nel settore delle superfici in gomma in ambito commerciale e sportivo, con il rapido sviluppo di tecnologie avanzate e l'apporto fondamentale di professionalità specifiche e di grande esperienza.

Così oggi nello stabilimento di Cairo Montenotte (Savona) nascono superfici dalle alte prestazioni, ideali per realizzare pavimenti di scuole, ospedali, spazi pubblici e molte altre tipologie di destinazione. Si parte sempre dalla gomma, naturale o sintetica, una materia prima con pochi eguali per resistenza ed elasticità di base, capace di aumentare le proprie performance tecniche attraverso processi evoluti che ne perfezionano le caratteristiche. Alla gomma si aggiungono le cariche minerali, i pigmenti naturali e gli acceleranti della vulcanizzazione, in dosi opportune in base al prodotto specifico che si vuole ottenere. La miscelazione è un momento importante, fondamentale per determinare la giusta consistenza del materiale ma anche per assicurare una distribuzione omogenea del colore. La gomma cruda, lasciata raffreddare e tagliata in festoni, assume già un aspetto elastico anche se espresso da una forma ancora grezza e disgregata. L'impasto viene quindi avviato alla linea di produzione per l'inizio del processo che permette di ottenere una vera e propria sfoglia dallo spessore compreso tra 2 e 5 mm. Dopo l'operazione di calandratura, che determina con precisione lo spessore del pavimento, il materiale viene sottoposto al processo di vulcanizzazione transitando senza interruzioni tra cilindri metallici in un regime di alta temperatura. Ne esce un nastro continuo e perfettamente planare, una superficie priva di irregolarità, variazioni di spessore e difetti strutturali.

Gli effetti superficiali e le textures che rappresentano il tratto distintivo di alcune collezioni, sono il risultato della particolare superficie dei cilindri oppure di stampi che tramite pressione determinano il disegno e la finitura desiderata. Soluzioni innovative, anche sul piano estetico e formale, risultato di un dialogo con progettisti e designer, spesso molto importanti come Ponti, Mollino o Albini, padre di uno dei bestseller dell'azienda, il "bollo" della Metropolitana Milanese. L'incontro e la successiva collaborazione con Sottsass Associati hanno segnato senza dubbio un punto di svolta nella più recente storia di Artigo. Ne sono nati alcuni prodotti che

oggi sono i punti di riferimento dell'ampio catalogo, come Kayar: un progetto complesso perché non interessa solo la superficie del pavimento ma la struttura stessa del materiale, nel cui impasto vengono inserite fibre di cocco che durante la miscelazione vengono sminuzzate e distribuite casualmente con lo scopo di conferire un'immagine naturale della superficie.

Novità aziendale dall'estetica naturale e fortemente contemporanea è invece Screed, risultato di una composizione di materiali rinnovabili. Grazie all'esclusiva fase di lavorazione manuale, Screed presenta una superficie liscia dall'effetto spatolato, esaltando l'imperfezione tipica dell'opera artigianale. Un prodotto ad alto contenuto ecologico, composto da gomma naturale, fibre e oli vegetali, che garantiscono alte prestazioni tecniche di resistenza, durabilità ed elasticità, nel rispetto dell'ambiente.

8 Soluzioni estetiche e progettuali complete, affiancate da prestazioni tecniche e funzionali uniche: superfici che non contengono pvc, metalli pesanti, alogeni, plastificanti volatili e assicurano una ridotta emissione di VOC (composti organici volatili). Dimostrazione del nostro impegno ambientale sono alcune importanti certificazioni internazionali ottenute in seguito a rigidi controlli dell'intero ciclo di produzione, dalla selezione delle materie prime al controllo delle emissioni, che qualificano i nostri pavimenti per i crediti secondo gli schemi ambientali LEED e BREEAM sugli edifici.

Artigo garantisce l'utilizzo di materiali antibatterici e igienici, al fine di proteggere ulteriormente ogni tipo di ambiente. Caratteristiche funzionali come leggerezza, spessore contenuto, rapidità di posa, facilità di manutenzione e possibilità di copertura di pavimentazioni preesistenti, ne fanno un'ottima soluzione per il rinnovo di edifici esistenti. Pavimenti che soddisfano la normativa internazionale per quanto riguarda la reazione al fuoco, garantendo una bassa opacità e tossicità dei fumi in caso d'incendio. Inoltre, l'applicazione di trattamenti superficiali PRO e TXL alla fine del processo permettono di migliorare la resistenza del prodotto riducendo significativamente i costi di gestione. I pavimenti Artigo consentono infine di migliorare le prestazioni complessive dell'ambiente anche a livello acustico con un abbattimento del rumore dovuto al calpestio che può raggiungere valori di riduzione fino a 20 db.

Un insieme di qualità esclusive che rendono oggi Artigo un partner affidabile, dinamico e sostenibile per qualsiasi progetto di architettura contemporanea nel quale sia richiesta una soluzione che associ resistenza, flessibilità e durata nel tempo, ma che sia anche in grado di esprimere un'emozione, di trasmettere il gusto del bello, di raccontare una storia d'eccellenza e di passione. Soluzioni che non si limitano a rappresentare una risposta efficace alle richieste pratiche del progetto, ma costituiscono una proposta dall'alto valore estetico, in grado di contribuire a rendere un ambiente piacevole, accogliente e a misura d'uomo.

Material that stands out for its technical and functional qualities, a journey dedicated to experimentation and continued research, a company that has been continuously active for almost a century, new and increasingly high-performance solutions and aesthetic interpretations that are constantly evolving.

Rubber is the foundation of our entire business. It has been since 1962 when the Pirelli Group gave birth to Artigo, a division dedicated to the development of flooring. In 1992 the company was acquired by Gruppo Mondo, a leader in rubber surfaces for the commercial and athletic sectors. Gruppo Mondo was able to rapidly develop the rubber flooring market with the use of advanced technologies and the fundamental addition of specific skills and extensive experience.

Today the Cairo Montenotte (Savona) facility manufactures high performance surfaces that are perfect for application in schools, hospitals, public spaces, and various other types of locations. The process always begins with rubber, natural or synthetic, a raw material that has few equals in terms of its fundamental durability and elasticity, and is able to increase its own technical performance through evolved manufacturing processes that perfect its characteristics. Mineral fillers, natural pigments, and vulcanisation accelerators are added to the rubber in the proper doses according to the specific product to be created. The mixing is an important moment, one that is fundamental in determining the right consistency of the material as well as for ensuring a uniform colour distribution. Raw rubber, left to cool and cut into festoons, immediately assumes an elastic appearance, even if derived from a shape that is still coarse and unrefined. The mixture is then sent to the production line to begin the process which results in the creation of rubber sheets between 2 and 5 mm thick. After the calendaring, which determines the precise thickness of the floor, the material undergoes the vulcanisation process, moving continuously between metal cylinders at high temperatures. What is produced is one continuous and perfectly flat strip, a surface with no irregularities, variations in thickness, or structural defects.

The superficial effects and textures which are distinctive traits of certain collections are created by the specific surfaces of the cylinders or by prints that, when pressed on, determine the design and the desired finish. Innovative solutions, also at the aesthetic and formal level, which are the product of an open dialogue with planners and designers, some quite well-known such as Ponti, Mollino, or Albin, the creator of one of the company's best-sellers, the "bubble" of the Milanese metro. The meeting and subsequent collaboration with Sottsass Associati undoubtedly marked a turning point in Artigo's recent history. Certain products were created which have today become reference points in the company's extensive

catalogue, such as Kayar: a complicated project because it not only involves the surface of the floor, but the actual structure of the material as well, the mixture of which uses coconut fibres that are broken up during mixing and randomly distributed to give the surface a natural look.

One of the company's newest products, featuring a natural and very modern aesthetic, is Screed, created from a composition of renewable materials. Thanks to a unique manual processing stage, Screed has a smooth surface featuring a spatula effect which exalts the imperfections typical of artisan craftsmanship. A highly ecological product, made of natural rubber, fibres, and vegetable oils guarantee high technical performance in terms of resistance, durability, and elasticity, while respecting the environment.

Complete aesthetic and design solutions, accompanied by unique technical and functional characteristics: surfaces that do not contain pvc, heavy metals, halogens, or volatile plasticizers and which ensure a reduction in emissions of VOC (volatile organic compounds). As proof of our commitment to the environment, we have received several important international certifications following inspections of our entire manufacturing cycle, from the selection of raw materials to the monitoring of emissions, which qualify our floors according to the LEED and BREEAM environmental building parameters.

Artigo guarantees the use of antibacterial and hygienic materials in order to further protect every kind of space. Functional characteristics like lightness, reduced thickness, speed of installation, ease of maintenance, and the option of covering pre-existing floors make this an excellent solution for the renovation of existing buildings. Floors that adhere to international regulations in terms of fire resistance, guaranteeing low opacity and smoke toxicity in the event of fire. Furthermore, the application of PRO and TXL surface treatments at the end of the manufacturing process allow for greater resistance, thus significantly reducing handling costs. Lastly, Artigo floors also improve the overall performance characteristics of a space at the acoustic level, with up to a 20 db reduction in noise level due to foot traffic.

An overall package of exclusive qualities that today make Artigo a reliable, dynamic, and sustainable partner for any contemporary architectural project requiring a solution that brings together resistance, flexibility, and durability, but which is also expressive, beautifully tasteful, and represents excellence and passion. Solutions that don't merely provide an effective answer to the practical requirements of a project, but which also provide great aesthetic value, helping to make a space pleasing, welcoming, and liveable.

Un matériau unique de par ses qualités techniques et fonctionnelles, un parcours d'expérimentation et de recherche continue, une histoire d'entreprise alimentée sans cesse depuis près d'un siècle, entre innovations toujours plus performantes et interprétations esthétiques en évolution permanente.

Le caoutchouc est au centre de toutes nos activités, et ce depuis 1962 lors de la naissance au sein du groupe Pirelli d'Artigo, la division spécialisée dans le développement des revêtements de sol. L'année 1992 a vu l'acquisition de la part du groupe Mondo, leader du secteur des surfaces en caoutchouc dans le domaine commercial et sportif, avec le développement rapide de technologies avancées et l'apport fondamental de professionnels spécifiques et de grande expérience.

Ainsi, l'établissement de Cairo Montenotte (Savona) donne aujourd'hui naissance à des surfaces de hautes performances, idéales pour réaliser des revêtements pour les écoles, les hôpitaux, les espaces publics et de nombreux autres types d'utilisations. Le matériau de départ est toujours le caoutchouc, naturel ou synthétique, une matière première ayant peu d'équivalents en termes de résistance et d'élasticité, capable d'augmenter ses performances techniques grâce à des processus évolués qui perfectionnent ses caractéristiques. Au caoutchouc sont ajoutés les charges minérales, les pigments naturels et les accélérateurs de vulcanisation, dosés spécifiquement en fonction du produit à obtenir. Le mélange est un moment important, fondamental pour déterminer la consistance appropriée du matériau, mais aussi pour assurer une distribution homogène de la couleur. Le caoutchouc cru, refroidit naturellement et découpé en festons, prend déjà un aspect élastique, même s'il possède une forme encore brute et désagrégée. La pâte est ensuite envoyée à la ligne de production pour le début du processus qui permet d'obtenir une véritable feuille d'une épaisseur comprise entre 2 et 5 mm. Après l'opération de calandrage, qui détermine avec précision l'épaisseur du revêtement, le matériau est soumis au processus de vulcanisation en passant sans interruptions entre des cylindres métalliques et soumis à une température élevée. Il en résulte un ruban continu et parfaitement plat, une surface exempte d'irrégularités, de variations d'épaisseurs et de défauts de structures.

Les effets de surfaces et les textures qui distinguent certaines collections sont le résultat de la surface particulière des cylindres ou des moules qui transmettent le dessin et la finition désirée par pression. Les solutions innovantes, notamment sur le plan esthétique et de la forme, sont le résultat d'un dialogue entre les concepteurs et les designers, souvent très importants comme Ponti, Mollino ou Albini, père de l'un des best-sellers de l'entreprise, la "pastille" du métro milanais.

La rencontre et la collaboration suivante avec Sottsass Associati ont marqué sans aucun doute un tournant dans l'histoire plus récente d'Artigo. Elles ont donné le jour à certains produits qui sont aujourd'hui les points de référence du vaste catalogue, comme Kayar: un projet complexe car il concerne non seulement la surface du revêtement, mais aussi la structure même du matériau, dans lequel sont mélangées des fibres de noix de coco qui sont hachées et distribuées de manière aléatoire durant le mélange dans le but de conférer une image naturelle à la surface.

Screed est en revanche une nouveauté de l'entreprise à l'aspect naturel et résolument contemporain, résultat d'une composition de matériaux renouvelables. Grâce à la phase exclusive de traitement manuel, Screed possède une surface lisse avec un effet brossé, qui fait ressortir l'imperfection typique du travail artisanal. Un produit à forte teneur écologique, composé de caoutchouc naturel, fibres et huiles végétales, qui assurent des prestations techniques de résistance, durabilité et élasticité, dans le respect de l'environnement.

Des solutions esthétiques et conceptuelles complètes, associées à des performances techniques et fonctionnelles uniques: des surfaces exemptes de PVC, métaux lourds, halogènes, plastifiants volatils et qui assure une faible émission de COV (composés organiques volatils). La preuve de notre engagement est fournie par la qualité des certifications internationales obtenues grâce à des contrôles stricts de l'ensemble du cycle de fabrication, de la sélection des matières premières au contrôle des émissions, qui qualifient nos revêtements pour les crédits selon les systèmes de normalisation environnementale des bâtiments LEED et BREEAM.

Artigo garantit l'utilisation de matériaux antibactériens et hygiéniques afin de protéger davantage tous les types d'espace. Les caractéristiques fonctionnelles comme la légèreté, la faible épaisseur, la rapidité de pose, la facilité d'entretien et la possibilité de couverture des revêtements existants en font une excellente solution pour la rénovation des bâtiments existants. Des revêtements qui satisfont la norme internationale de réaction au feu, en garantissant une faible opacité et toxicité des fumées en cas d'incendie. En outre, l'application de traitements de surface PRO et TXL à la fin du processus permet d'améliorer la résistance du produit en réduisant considérablement les coûts de gestion. Les revêtements Artigo permettent enfin d'améliorer les performances globales de l'espace au niveau acoustique avec une réduction du bruit de pas qui peut atteindre des valeurs de -20 dB.

Un ensemble de qualités exclusives qui rendent aujourd'hui Artigo un partenaire fiable, dynamique et durable pour tout projet d'architecture contemporaine qui exige une solution associant résistance, flexibilité et durée dans le temps, mais qui doit être également capable d'exprimer une émotion, de transmettre le goût de la beauté, de raconter une histoire d'excellence et de passion. Des solutions qui ne se limitent pas à représenter une réponse efficace aux exigences pratiques du projet, mais qui constituent une proposition à forte valeur esthétique, capable de contribuer à rendre un espace agréable, accueillant et aux dimensions humaines.

Ein einzigartiger Werkstoff wegen seinen technischen und funktionellen Eigenschaften, eine durch unablässige Versuche und Forschung gekennzeichnete Entwicklung, eine Unternehmensgeschichte, die seit fast einem Jahrhundert ohne Unterbrechungen durch neue, immer leistungsfähigere Lösungen und sich kontinuierlich wandelnde ästhetische Auslegungen geprägt ist.

Der Kautschuk bildet den Mittelpunkt unseres Wirkens, und zwar seit 1962, als innerhalb des Konzerns Pirelli Artigo gegründet wurde, ein auf die Entwicklung von Bodenbelägen spezialisierter Unternehmensbereich. 1992 erfolgt die Übernahme durch die Mondo-Gruppe, ein führendes Unternehmen im Sektor der Kautschukoberflächen im Objekt- und Sportbereich, mit der schnellen Weiterentwicklung hochmoderner Technologien und dem ausschlaggebenden Beitrag fachspezifischer Kenntnisse und großer Erfahrung.

Heute entstehen im Werk von Cairo Montenotte (Savona) hochleistungsfähige Oberflächen, die sich ideal als Bodenbeläge für Schulen, Krankenhäuser, öffentliche Gebäude und viele andere Verwendungszwecke eignen. Am Anfang steht stets der Kautschuk, ein Rohstoff, dem hinsichtlich seiner grundlegenden Merkmale in Bezug auf Beständigkeit und Elastizität nur wenige ebenbürtig sind und der in der Lage ist, seine technischen Leistungen durch hoch entwickelte Verfahren zu steigern, die seine Eigenschaften perfektionieren. Dem Kautschuk werden mineralische Füllstoffe, natürliche Pigmente und Vulkanisationsbeschleuniger in den entsprechenden Dosierungen, abhängig von dem spezifischen herzustellenden Produkt, hinzugefügt. Der Mischvorgang ist ein wichtiger Moment und von ausschlaggebender Bedeutung zum Erreichen der richtigen Konsistenz des Werkstoffs, doch auch, um eine gleichmäßige Farbverteilung zu erzielen. Abgekühlter und in Segmente geschnittener Rohkautschuk erscheint bereits elastisch, auch wenn dies noch in einem rohen und unfertigen Stadium ist. Die Mischung wird dann der Produktionslinie zugeführt, um das Verfahren zu starten, mit dem es möglich ist, eine echte Bodenbelagsbahn mit einer Stärke zwischen 2 und 5 mm zu erhalten. Nach dem Kalandriervorgang, der die Stärke des Bodens genau festlegt, wird der Werkstoff dem Vulkanisierungsverfahren unterzogen, bei dem er ohne Unterbrechungen bei hohen Temperaturen über Metallzylindern läuft. Daraus ergibt sich eine kontinuierliche und perfekt ebene Bahn und eine von Unregelmäßigkeiten, Stärkenabweichungen und strukturellen Defekten freie Oberfläche. Die Oberflächenwirkungen und die Beschaffenheiten, die einige Kollektionen auszeichnen, sind das Ergebnis der besonderen Oberfläche der Zylinder bzw. von Formen, die durch Druck das Muster und das gewünschte Finish erzielen. Innovative Lösungen, auch was Ästhetik und Form betrifft, und das Ergebnis eines Dialogs mit Planern und Designern mit häufig bedeutenden Namen wie Ponti, Molino oder Albini, Vater eines

der Bestseller des Unternehmens, dem "Noppenfußboden" der Mailänder U-Bahn. Das Zusammentreffen und die anschließende Zusammenarbeit mit Sottsass Associati haben in der jüngsten Geschichte von Artigo zweifellos einen Wendepunkt dargestellt. Daraus gingen einige Produkte hervor, die heute fester Bestandteil des umfassenden Katalogs sind, wie z. B. Kayar: ein komplexes Projekt, weil es nicht nur die Bodenoberfläche, sondern die Struktur des Werkstoffs selbst betrifft, dessen Mischung Kokosfasern hinzugefügt werden, die während des Mischvorgangs nach dem Zufallsprinzip zerkleinert und verteilt werden, um der Oberfläche ein natürliches Aussehen zu verleihen.

14 Eine der Neuheiten des Unternehmens mit natürlicher und ausgeprägt zeitgemäßer Ästhetik ist Screed, das Ergebnis einer Komposition aus erneuerbaren Werkstoffen. Dank des exklusiven manuellen Bearbeitungsschritts weist Screed eine glatte Oberfläche mit Spachteleffekt auf und betont damit die typische Unvollkommenheit der handwerklichen Arbeit. Ein in hohem Maße umweltfreundliches Produkt aus Naturkautschuk, Fasern und Pflanzenölen, die hohe technische Leistungen in Bezug auf Strapazierfähigkeit, Haltbarkeit und Elastizität bei gleichzeitiger Umweltfreundlichkeit garantieren.

Komplette ästhetische und planerische Lösungen, die mit einzigartigen technischen und funktionellen Leistungen einhergehen: Oberflächen, die weder PVC, Schwermetalle, Halogene noch flüchtige Weichmacher enthalten und eine geringere Freisetzung von VOCs (flüchtigen organischen Verbindungen) garantieren. Beweis für unser Engagement für den Umweltschutz sind einige wichtige internationale Zertifizierungen, die nach strengen Kontrollen des gesamten Produktionszyklus, von der Auswahl der Rohstoffe bis zur Kontrolle der Emissionen, erteilt wurden und unsere Böden für die Punktevergabe nach den Systemen LEED und BREEAM für energie- und umweltfreundliche Gebäude qualifizieren.

Artigo garantiert die Verwendung von antibakteriellen und hygienischen Werkstoffen, um jegliche Arten von Räumen noch besser zu schützen. Funktionelle Eigenschaften wie niedriges Gewicht, geringe Stärke, schnelle Verlegbarkeit, mühelose Wartung und die Möglichkeit des Abdeckens bereits bestehender Bodenbeläge machen sie zur einer hervorragenden Lösung bei der Renovierung bestehender Gebäude. Böden, die die internationalen Bestimmungen hinsichtlich ihres Brandverhaltens erfüllen und eine geringe Verdunkelung und Giftigkeit des Rauchs im Brandfall garantieren. Außerdem gestatten die Oberflächenbehandlungen PRO und TXL am Ende des Verfahrens eine Verbesserung der Widerstandsfähigkeit des Produktes und senken damit die Unterhaltungskosten erheblich. Artigo-Bodenbeläge verbessern außerdem die Eigenschaften des Raums insgesamt auch in Hinblick auf den Schallpegel durch ein Senken der Trittschallgeräusche, die um bis zu 20 db verringert werden können.

Eine Reihe exklusiver Eigenschaften, die Artigo heute zu einem zuverlässigen, dynamischen und nachhaltigen Partner für sämtliche Projekte zeitgemäßer Architektur machen, bei denen eine Lösung gefragt ist, die Widerstandsfähigkeit, Flexibilität und lange Lebensdauer in sich vereint, doch auch in der Lage ist, einem Gefühl Ausdruck zu verleihen, die Freude am Schönen zu vermitteln und eine Geschichte von Exzellenz und Passion zu erzählen. Lösungen, die sich nicht darauf beschränken, eine wirksame Antwort auf praktische Projektanforderungen zu bieten, sondern eine Option von hohem ästhetischen Wert darstellen, die in der Lage ist, dazu beizutragen, einen Raum angenehm, einladend und menschengerecht zu gestalten.

Un material único por su calidad técnica y funcional, un proceso de experimentación e investigación constante, una historia empresarial alimentada con continuidad durante casi un siglo, entre nuevas soluciones que ofrecen mayores prestaciones e interpretaciones estéticas que evolucionan constantemente.

Todas nuestras actividades se basan en el caucho, desde que en 1962 en el marco del Grupo Pirelli se fundó Artigo, la división dedicada al desarrollo de pavimentos. En 1992 tuvo lugar su adquisición por parte del Grupo Mondo, líder en el sector de las superficies de caucho a nivel comercial y deportivo, con el rápido desarrollo de tecnologías avanzadas y la aportación esencial de profesionales con experiencia.

Por eso hoy en la planta de Cairo Montenotte (Savona) nacen revestimientos de altas prestaciones, ideales para realizar pavimentos de escuelas, hospitales, áreas públicas y muchas aplicaciones más. Se empieza siempre a partir del caucho, natural o sintético, una materia prima prácticamente inigualable por su resistencia y elasticidad básicas, que puede aumentar su rendimiento técnico a través de una serie de procesos avanzados que perfeccionan sus características. Al caucho se le añaden cargas minerales, pigmentos naturales y aceleradores de la vulcanización, en dosis apropiadas dependiendo del producto específico que se desea obtener. La mezcla es una fase importante y esencial para determinar la consistencia adecuada del material, pero también para asegurar una distribución homogénea del color. El caucho crudo, cuando se deja enfriar y se corta en festones, ya cobra un aspecto elástico aunque se exprese con una forma poco refinada y desintegrada. La masa pasa luego a la línea de producción para emprender el proceso que permite obtener una verdadera lámina con un espesor comprendido entre 2 y 5 mm. Después de la operación de calandrado, que determina con precisión el espesor del pavimento, el material se somete al proceso de vulcanización pasando sin interrupción entre cilindros de metal a alta temperatura. El resultado es una cinta continua y perfectamente plana, una superficie sin irregularidades, variaciones de espesor ni defectos estructurales.

Los efectos de la superficie y las texturas que representan la personalidad de algunas colecciones resultan de la configuración de los cilindros o de matrices que por medio de la presión determinan el diseño y el acabado deseado. Se trata de soluciones innovadoras, incluso a nivel estético y formal, resultantes de un diálogo con los proyectistas y diseñadores -en general muy importantes- como Ponti, Mollino o Albini, que es el creador de uno de los más vendidos de nuestra

INSPIRATIONS

empresa, el pavimento de “círculos” del metro de Milán. Conocer y colaborar con Sottsass Associati ha marcado un hito decisivo en la historia reciente de Artigo. De ahí han nacido algunos productos que representan los puntos de referencia actuales de nuestro amplio catálogo, como Kayar: un proyecto complejo, ya que no sólo concierne a la superficie del pavimento, sino a la estructura del material, en cuya masa se colocan fibras de coco durante el mezclado que se cortan y se distribuyen al azar para dar una imagen natural de la superficie.

Otra novedad de la empresa que ofrece una estética natural y muy contemporánea es Screed, el resultado de una composición de materiales renovables. Gracias a la exclusiva fase de procesamiento manual, Screed presenta una superficie lisa con efecto espátula, haciendo resaltar la imperfección típica del trabajo artesanal. Un producto de alto contenido ecológico, compuesto por caucho natural, fibras y aceites vegetales, que garantizan altas prestaciones técnicas de resistencia, durabilidad y elasticidad, respetando el medio ambiente.

Soluciones estéticas y proyectuales completas, integradas por prestaciones técnicas y funcionales incomparables: superficies que no contienen PVC, metales pesados, halógenos, plastificantes volátiles y aseguran un bajo contenido de COV (compuestos orgánicos volátiles). Una parte de nuestro compromiso con el medio ambiente está representada por algunas certificaciones internacionales importantes que se han obtenido a raíz de un estricto control de todo el ciclo de producción, desde la selección de materias primas al control de emisiones, que califican nuestros pavimentos para los créditos según los esquemas ambientales LEED y BREEAM sobre edificios.

Artigo garantiza el uso de materiales antibacterianos e higiénicos, con objeto de proteger cualquier entorno. Algunas características funcionales como peso ligero, espesor reducido, rapidez de instalación, facilidad de mantenimiento y la posibilidad de cubrir pavimentos existentes, hacen que sea una buena solución para renovar cualquier edificio. Estos pavimentos cumplen con la normativa internacional en materia de reacción al fuego, garantizando una baja opacidad y toxicidad de los humos en caso de incendio. Por otra parte, la aplicación de tratamientos superficiales PRO y TXL al final del proceso permiten mejorar la resistencia del producto reduciendo significativamente los costes de mantenimiento. Los pavimentos Artigo ayudan a mejorar las prestaciones generales del entorno incluso a nivel acústico con una reducción del ruido debido al impacto que puede alcanzar valores de reducción de hasta 20 dB.

Un conjunto de cualidades exclusivas que hacen de Artigo un interlocutor fiable, dinámico y sostenible para cualquier proyecto de arquitectura contemporánea en el que se necesite una solución que combine resistencia, flexibilidad y durabilidad, pero que también sepa expresar una emoción, transmitir el gusto por la belleza o contar una historia de excelencia y pasión. Estas soluciones no sólo representan una respuesta eficaz a las necesidades prácticas del proyecto, sino que constituyen una propuesta de alto valor estético y pueden ayudar a hacer un entorno agradable, acogedor y a escala humana.



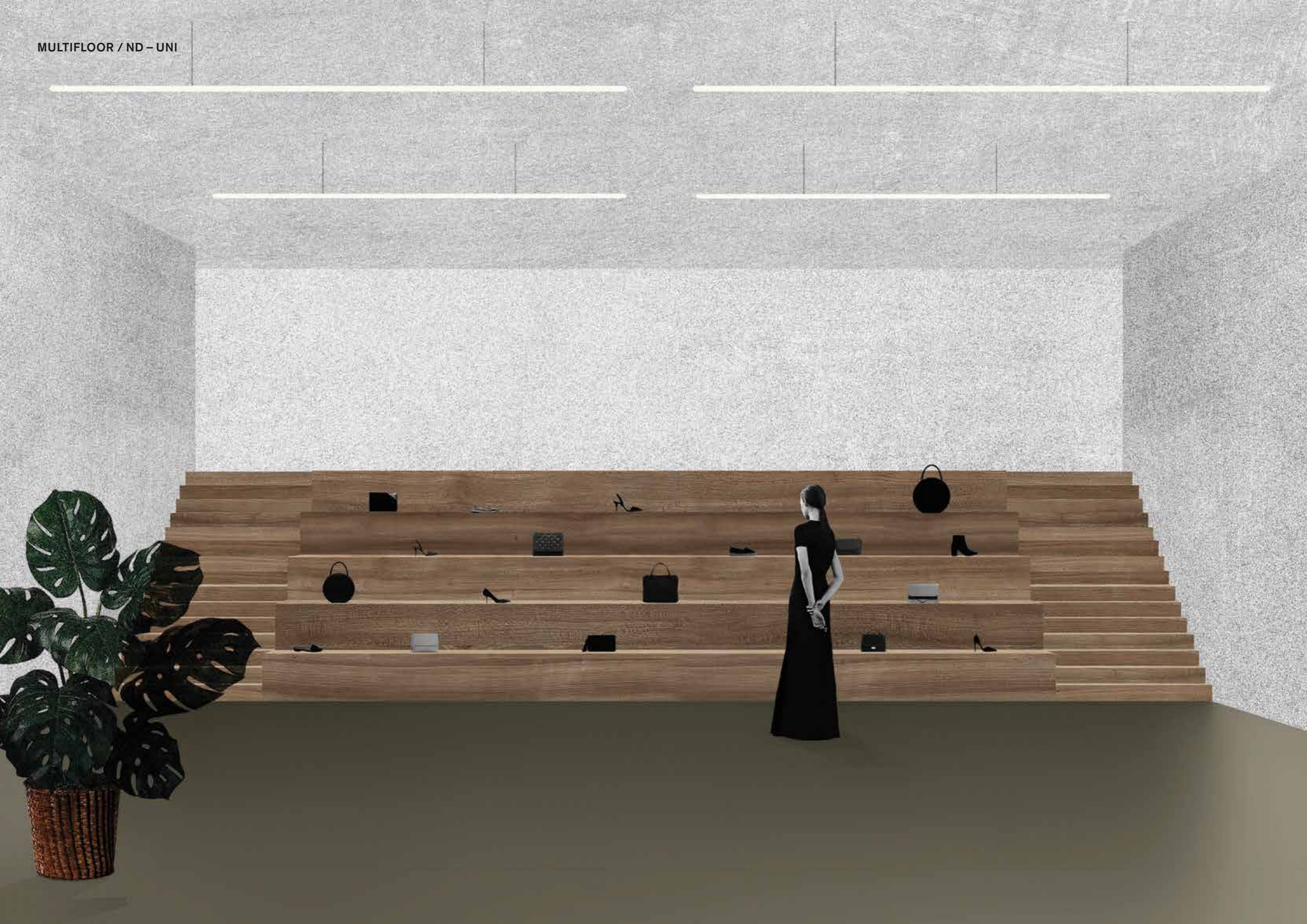



GRANITO

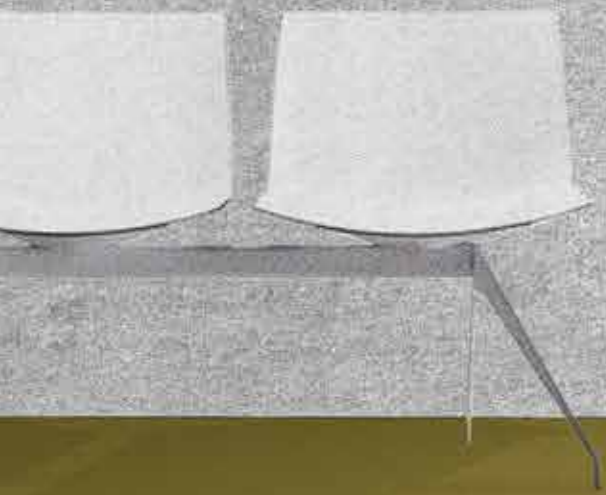



KAYAR



KAYAR





LAVA



ZEUS

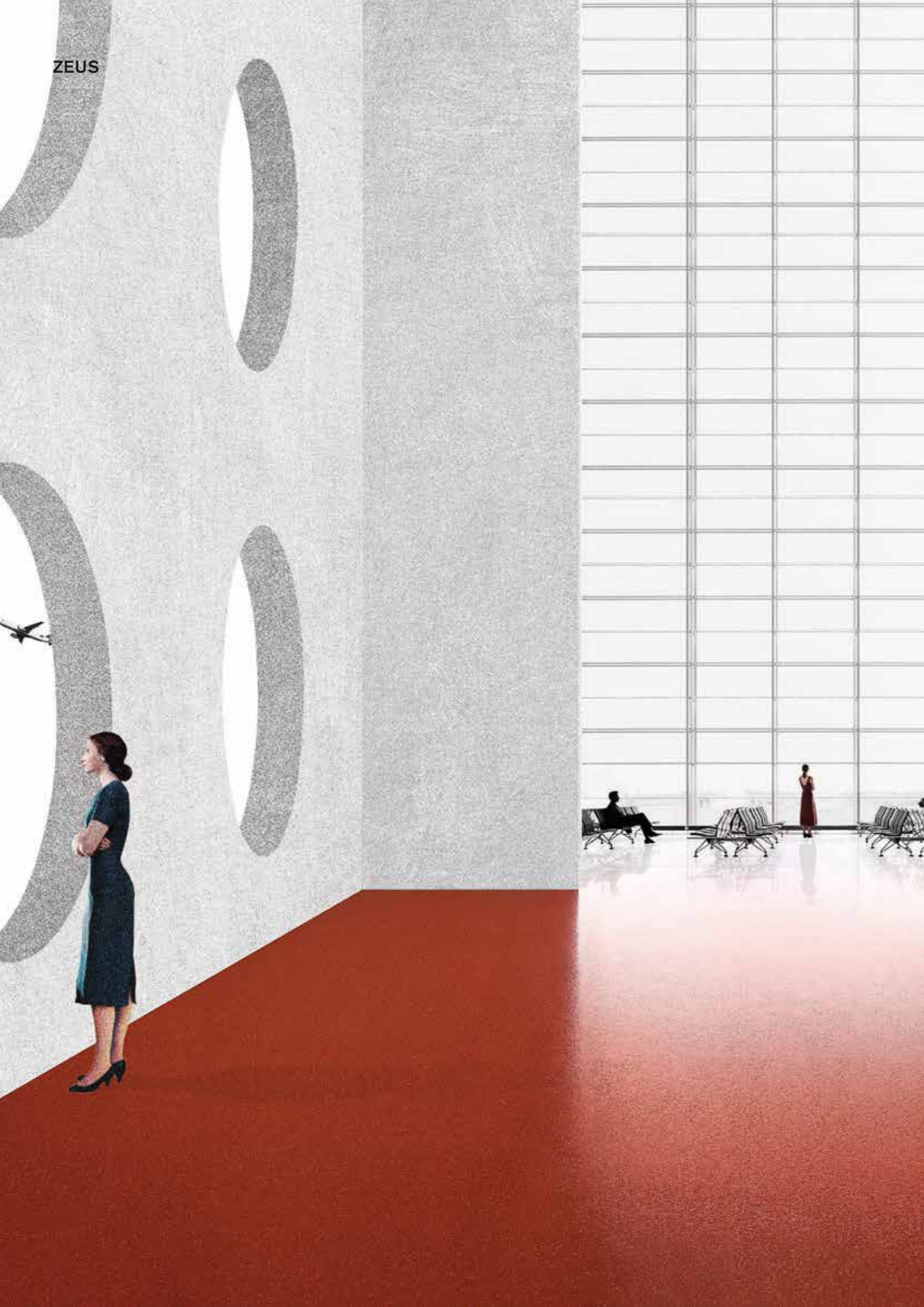

GRAIN

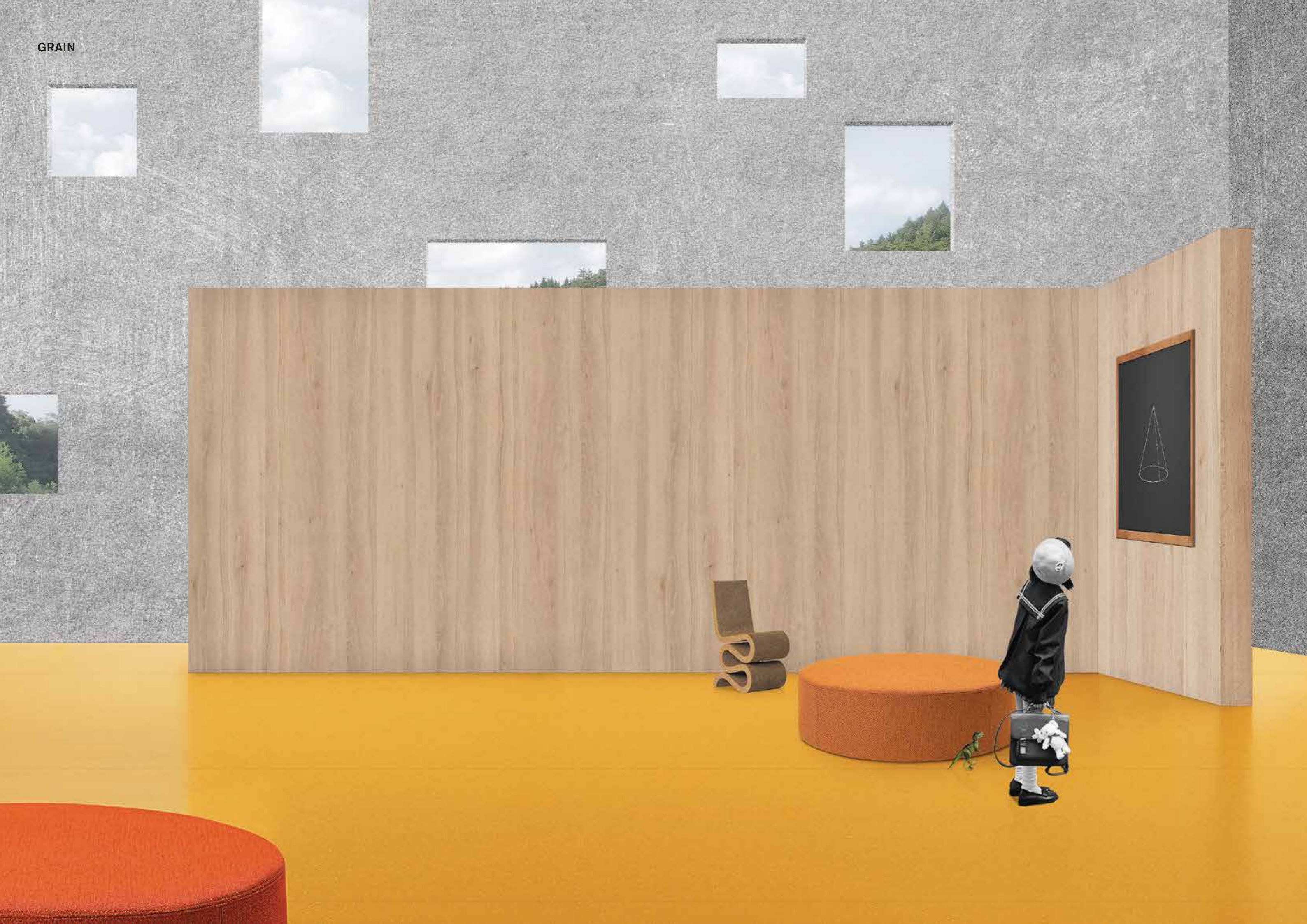

BS CLASSIC

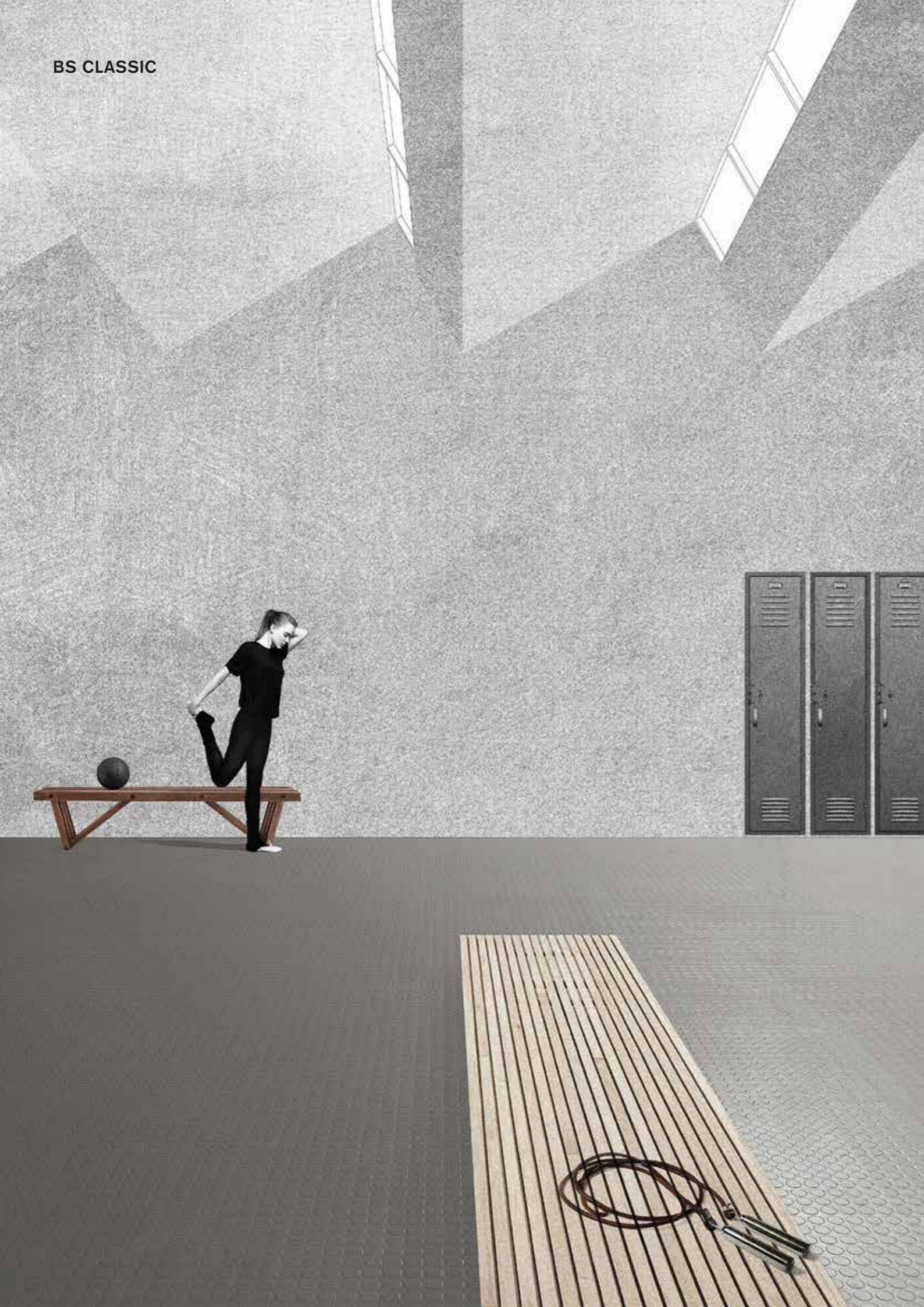

TECHNICALS

DHARMA

Superficie liscia con micro granuli.
 Smooth surface with micro granules.
 Surface lisse avec micro granules.
 Glatte Oberfläche mit Mikrokörnung.
 Superficie lisa con micro gránulos.



X-Elastic acoustic flooring

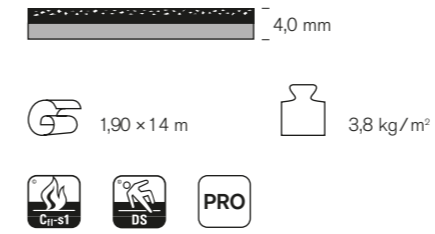

D16 Spice



D17 Cedar



D18 Saffron



D20 Papaya



D19 Pompei



D12 Vanilla



D14 Juta



D11 Musk



D15 Almond



D13 Oak



D10 Moon



D07 Palladium



D08 Air



D06 Island



D05 Midnight



D02 Linen



D09 Ash



D04 Elephant



D03 Seal





D01 Onyx

KAYAR



Superficie liscia con fibre naturali.
 Smooth surface with natural fibers.
 Surface lisse avec fibres naturelles.
 Glatte Oberfläche mit Naturfasern.
 Superficie lisa con fibras naturales.

 3,0 mm

 610 x 610 mm

 1,90 x 10 m

 4,8 kg/m²



   Classification UPEC **U₄ P₃ E₂ C_{1/2}**

X-Elastic acoustic flooring

 5,0 mm

 1,90 x 10 m

 5,4 kg/m²

46



K 72

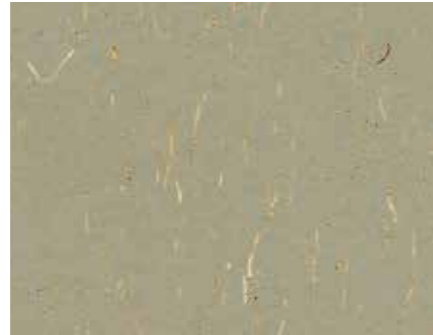

K 38



K 39



K 71



K 48

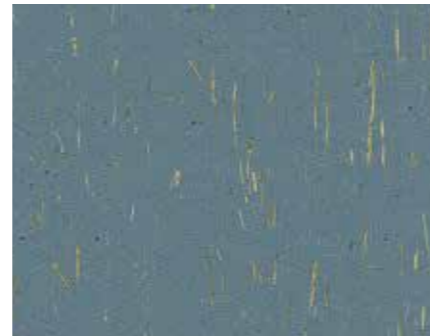

K 64



K 74



K 63



K 62



K 70



K 102



K 61

47

Plansystem

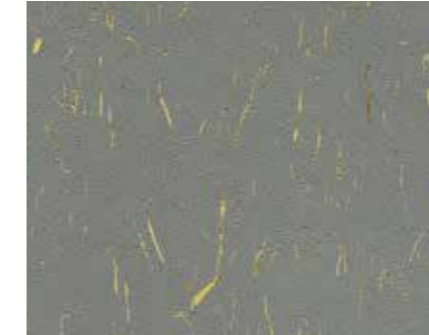

K 17



K 27



K 52



K 21



K 58



K 73



K 01



K 54



K 104



K 00

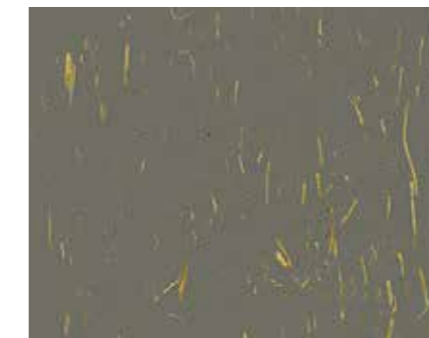

K 103

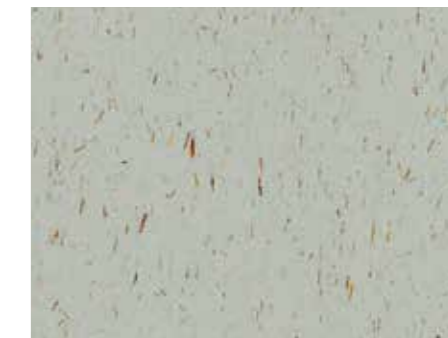



K 49

MULTIFLOOR / ND – UNI



Superficie liscia in tinta unita.
 Smooth surface in solid colours.
 Surface lisse en teinte unie.
 Glatte Oberfläche in einfarbiger Version.
 Superficie lisa en color único.

 3,0 mm

 610 x 610 mm

 1,90 x 10 m

 5,1 kg/m²



   Classification UPEC **U₄ P₃ E₂ C_{1/2}**

X-Elastic acoustic flooring

 5,0 mm

 1,90 x 10 m

 5,7 kg/m²

48



U 108 Canary



U 95 Summer

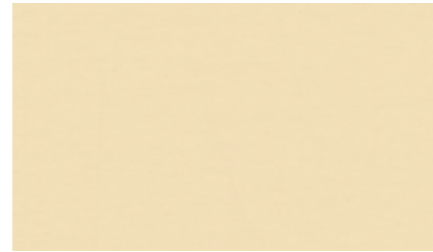

U 87 Cream



U 11 Gold



U 107 Lime



U 27 Sand



U 105 Tangerine



U 106 Bamboo



U 128 Cashmere



U 130 Crimson

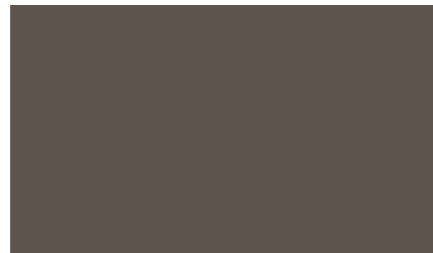

U 39 Olive

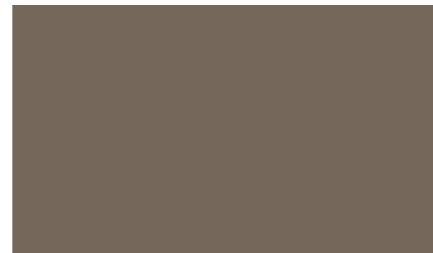

U 56 Navajo

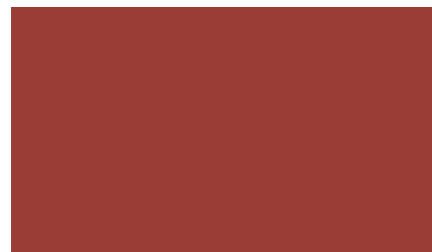

U 13 Firebrik

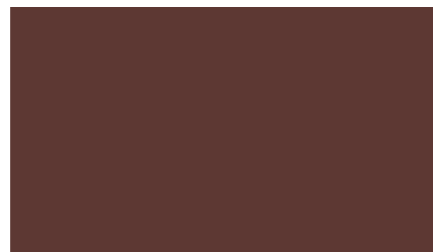

U 14 Mahogany



U 123 Brown



U 99 Ice



U 129 Horizon



U 20 Smoke



U 36 Silk



U 109 Pearl



U 17 Metal



U 54 Greige

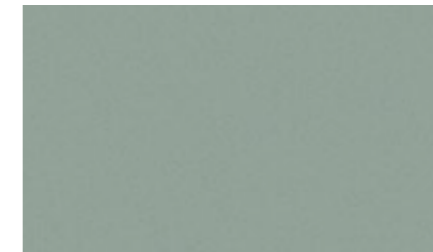

U 26 Steel



U 21 Eiffel

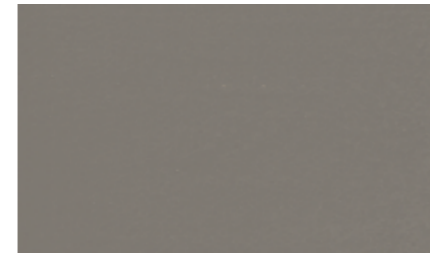

U 124 Fossil



U 16 Avio

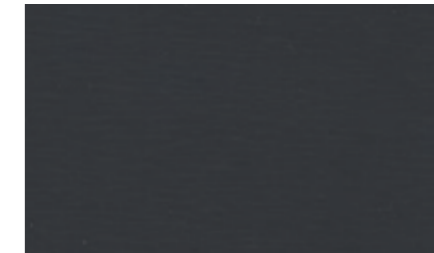

U 110 Slate

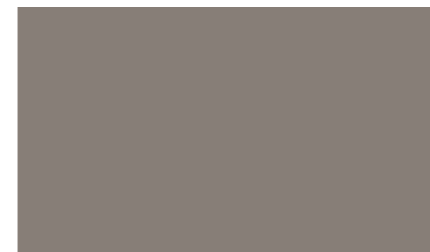

U 55 Stone



U 18 Grape





U 00 Carbon

49
Plansystem

GRANITO



Superficie liscia con finissimi grani multicolori.
 Smooth surface with multicoloured granules.
 Surface lisse avec de très fins granules multicolores incorporés.
 Glatte Oberfläche mit sehr feiner verschiedenfarbiger Körnung.
 Superficie lisa con pequeñas partículas multicolores.

 2,0 mm

 610 x 610 mm

 1,90 x 14 m

 3,1 kg/m²



   Classification UPEC **U₄ P₃ E₂ C_{1/2}**

X-Elastic acoustic flooring

 4,0 mm

 1,90 x 14 m

 3,7 kg/m²

  

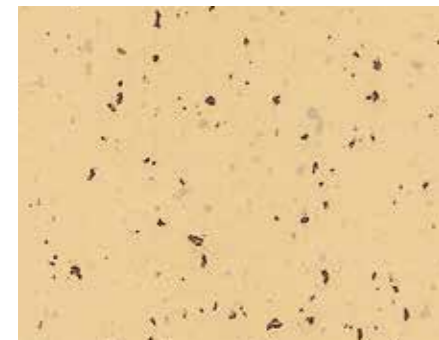

G 315

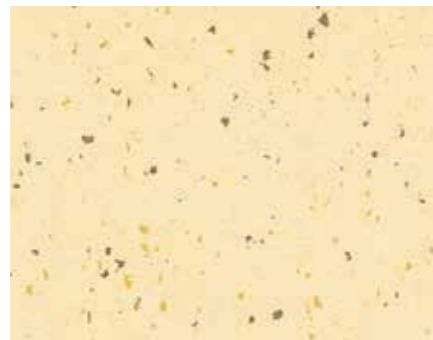

G 363

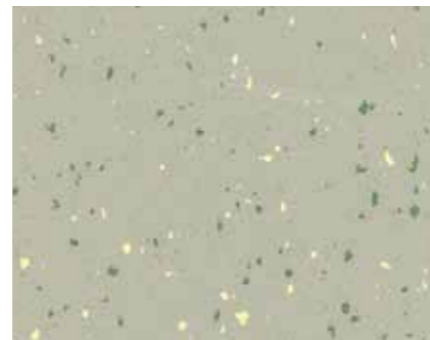

G 370



G 479



G 431

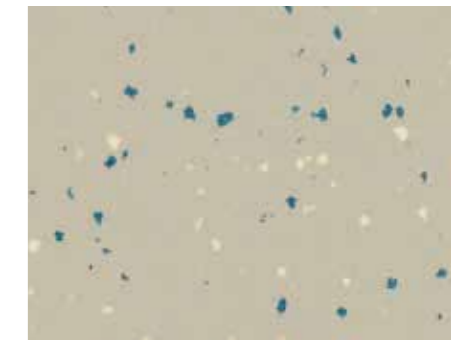

G 480

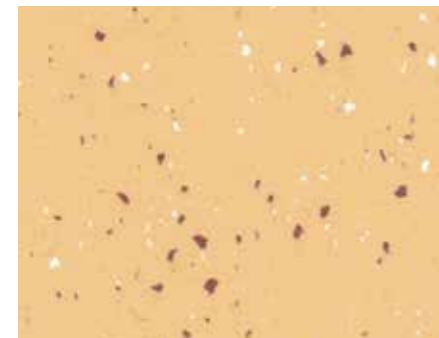

G 365

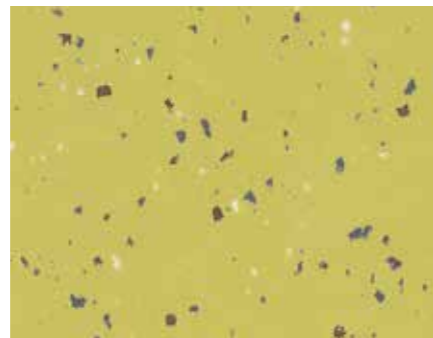

G 473

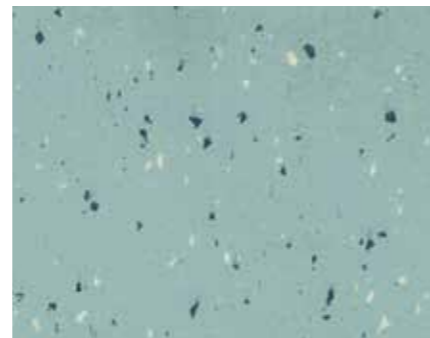

G 371

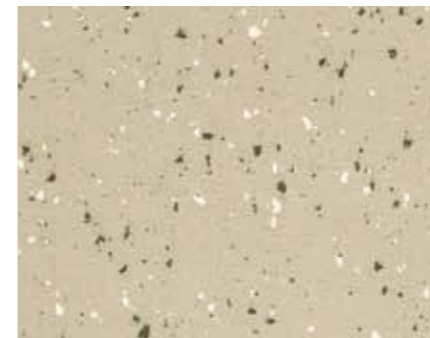

G 368

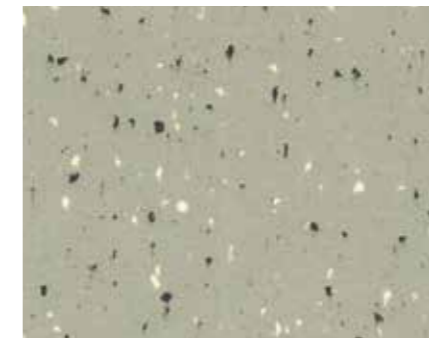

G 305



G 478



G 472

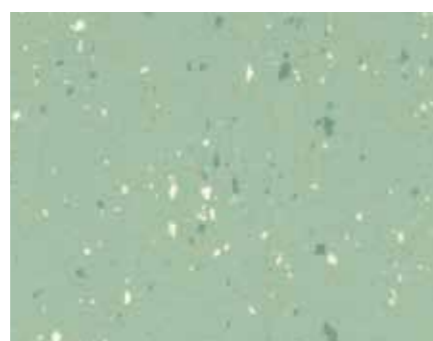

G 378

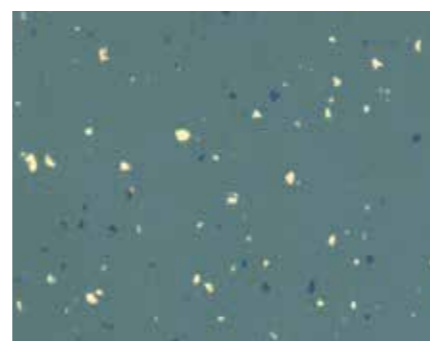

G 372

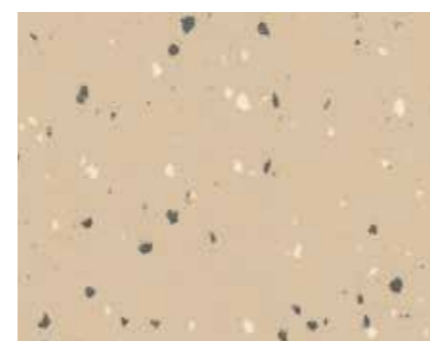

G 475



G 306

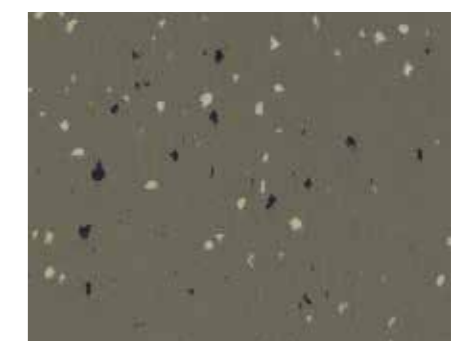

G 477



G 367

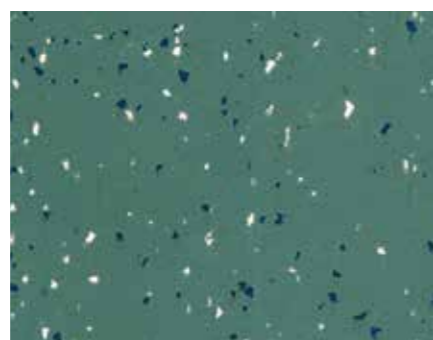

G 336

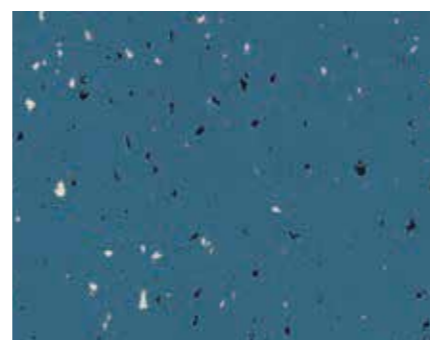

G 342

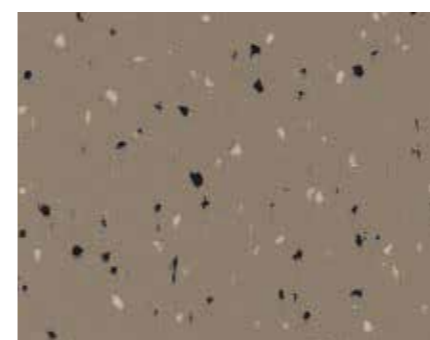

G 474

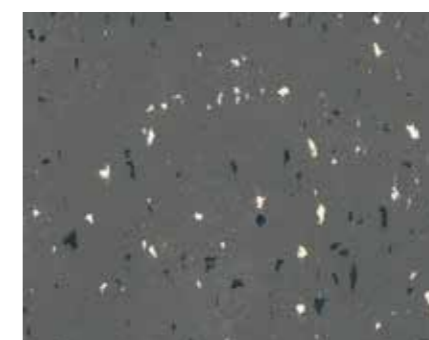

G 308



G 476

GRAIN

Superficie liscia con grani multicolori.
 Smooth surface with multicoloured granules.
 Surface lisse avec de granules multicolores incorporés.
 Glatte Oberfläche mit verschiedenfarbiger Körnung.
 Superficie lisa con partículas multicolores.

3,0 mm

610 × 610 mm

1,90 × 10 m

4,7 kg/m²

Classification UPEC **U₄ P₃ E₂ C_{1,2}**

X-Elastic acoustic flooring

5,0 mm

1,90 × 10 m

5,3 kg/m²



HG 105



HG 106



HG 115

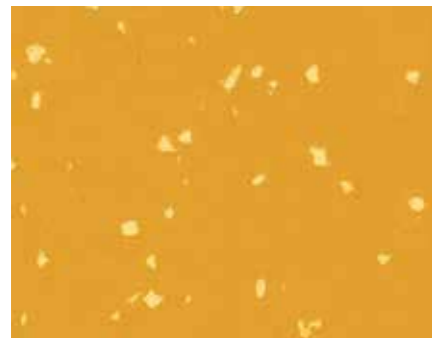

HG 111



HG 114



HG 116



HG 109

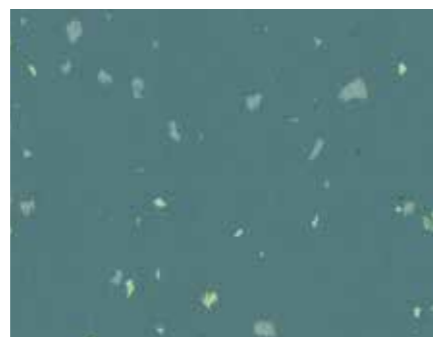

HG 112

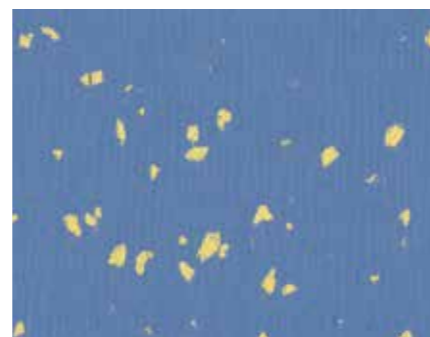

HG 113



HG 110



HG 118



HG 107

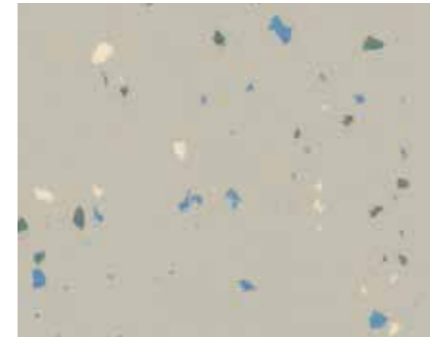

HG 120



HG 100



HG 104



HG 103



HG 123

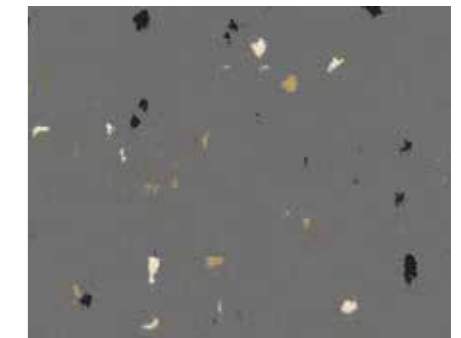

HG 119



HG 117



HG 101



HG 108



HG 121



HG 102



HG 122

SCREED

Superficie liscia con aspetto spatolato.
 Smooth surface with painted concrete look.
 Surface lisse aspect béton taloché.
 Glatte Oberfläche mit gestrichener Betonoptik.
 Superficie lisa con aspecto fratasado.



3,0 mm



610 x 610 mm



1,90 x 10 m



4,8 kg/m²



C_{fl-s1}



DS



PRO



ECO

Classification UPEC **U₄ P₃ E₂ C_{1/2}**

X-Elastic acoustic flooring



5,0 mm



1,90 x 10 m



5,4 kg/m²



C_{fl-s1}



DS



PRO



ECO

54



S 01 Ivory

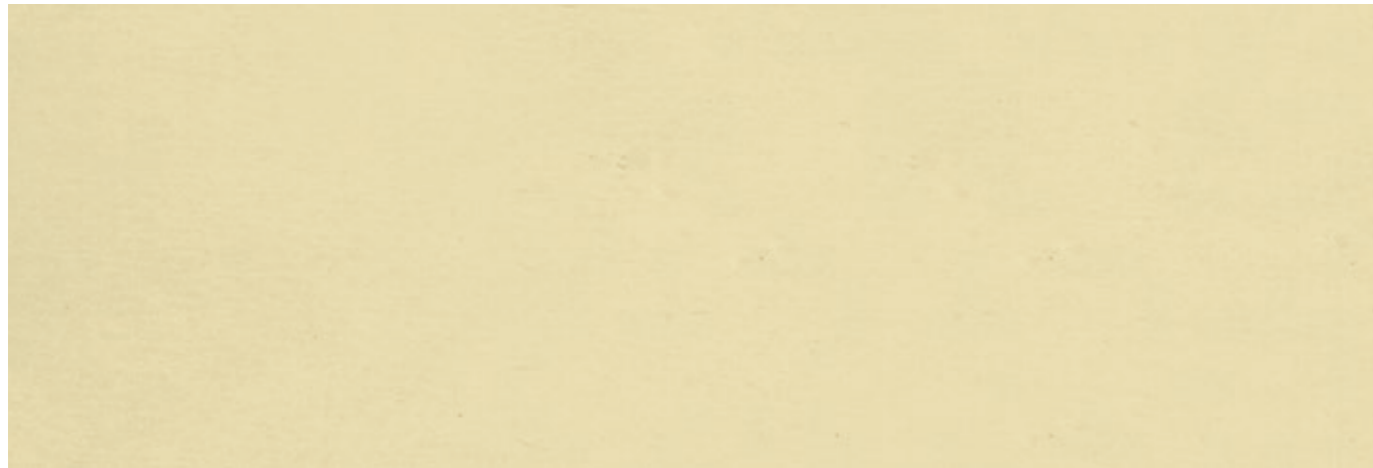

S 02 Antique



S 03 Greige

55

Plansystem



S 04 Haze



S 05 Cement









S 06 Charcoal

LAVA

Superficie gofrata con effetto pietra.
 Stone effect embossed surface.
 Surface gaufrée aspect pierre.
 Geprägte Oberfläche mit Steinoptik.
 Superficie gofrada con aspect piedra.



 3,0 mm





 610 × 610 mm  1,90 × 10 m  4,7 kg/m²

    Classification UPEC **U₄ P₃ E₂ C_{1/2}**

X-Elastic acoustic flooring

 5,0 mm

 1,90 × 10 m  5,3 kg/m²

56



L 03 Vesuvio



L 02 Teide

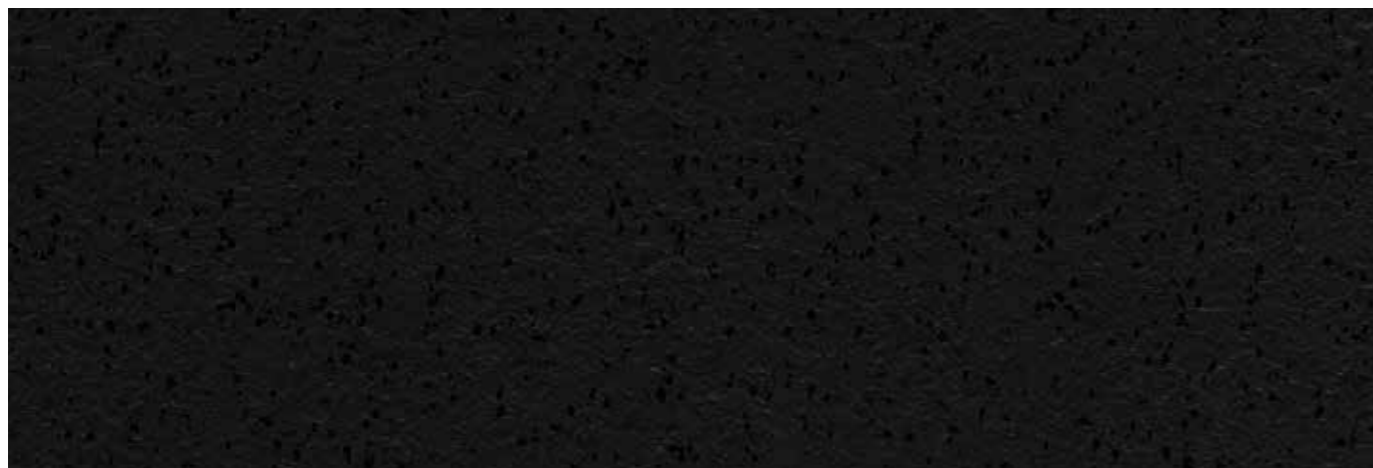

L 04 Kilauea

57

Plansystem

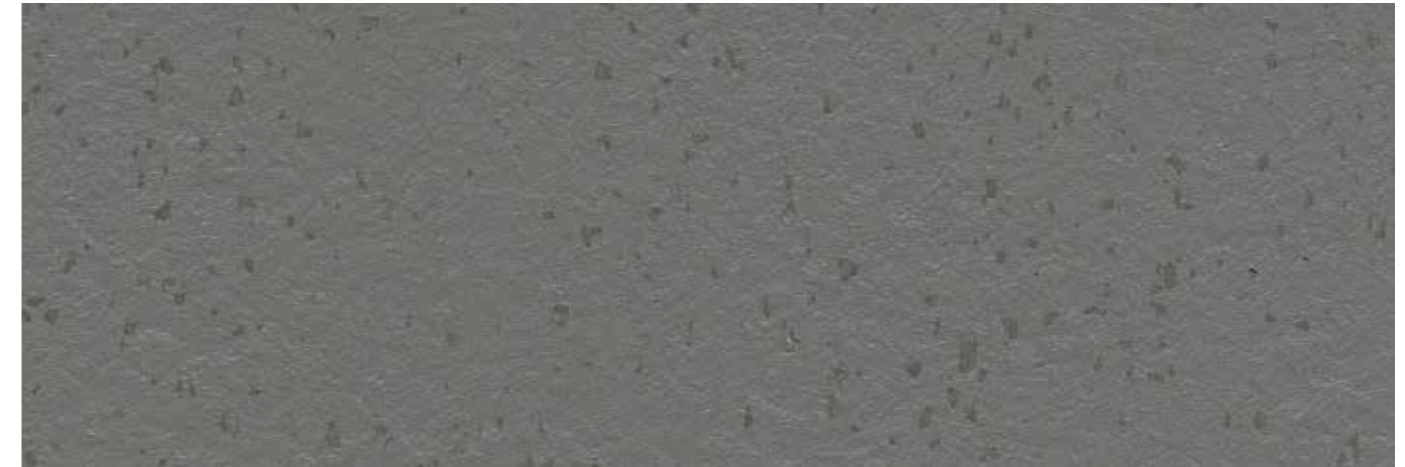

L 06 Fuji



L 01 Merapi



L 05 Etna

NATURA

Superficie liscia con marmorizzazione lineare.
 Smooth surface with linear marbling.
 Surface lisse à marbrures linéaires.
 Glatte Oberfläche mit linearer Marmorierung.
 Superficie lisa con marmoleado lineal.

3,0 mm

610 x 610 mm

1,90 x 10 m

4,9 kg/m²

Classification UPEC **U₄ P₃ E₂ C_{1/2}**

X-Elastic acoustic flooring

5,0 mm

1,90 x 10 m

5,5 kg/m²

58



NA 01 Cream



NA 04 Sand



NA 02 Hay



NA 08 Desert



NA 03 Summer



NA 06 Walnut



NA 07 Ecreu



NA 05 Greige



NA 09 Cliff



NA 10 Nimbus



NA 11 Metal



NA 12 Charcoal

59 Plansystem

KAYAR / LL

Autoposante. Superficie liscia con fibre naturali.
 Loose lay. Smooth surface with natural fibers.
 Autoportant. Surface lisse avec fibres naturelles.
 Zur losen Verlegung. Glatte Oberfläche mit Naturfasern.
 Autoposante. Superficie lisa con fibras naturales.



K 73



K 104



K 54

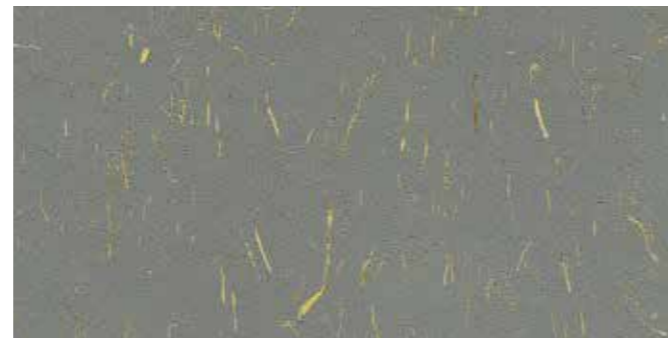

K 17



K 103



K 21



K 72



K 01

UNI / LL

Autoposante. Superficie liscia in tinta unita.
 Loose lay. Smooth surface in solid colour.
 Autoportant. Surface lisse en teinte unie.
 Zur losen Verlegung. Glatte Oberfläche in einfarbiger Version.
 Autoposante. Superficie lisa en color único.

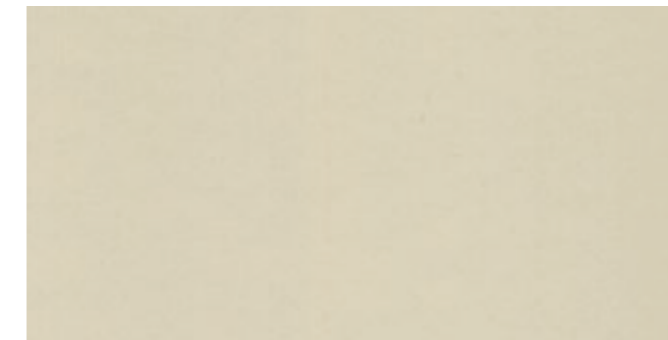
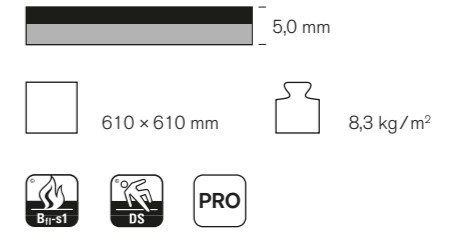

U 99



U 54



U 27



U 17

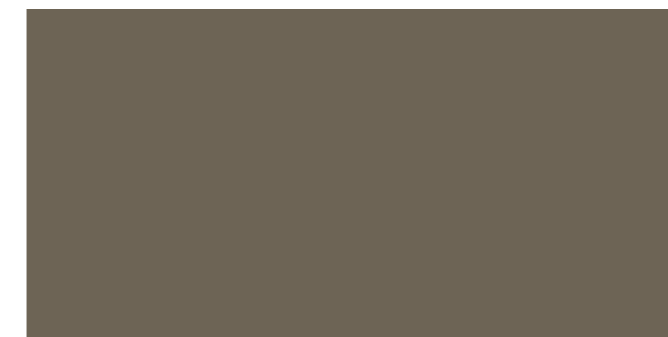

U 55



U 21



U 105

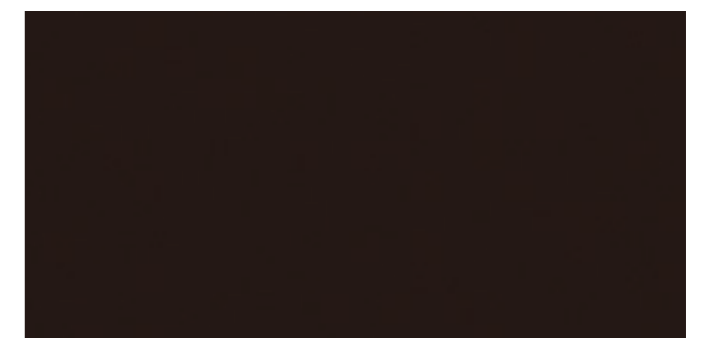

U 00

GRANITO / ANT 48

Pavimento dissipativo. Superficie gofrata.
 Dissipative flooring. Embossed surface.
 Revêtement de sol dissipateur. Surface gauffrée.
 Ableitfähige Bodenbeläge. Reflexbrechende Oberfläche.
 Pavimento disipativo. Superficie gofrada.

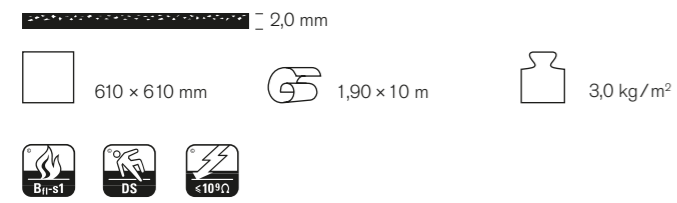

GRANITO X-Elastic

Pavimento acustico.
 Acoustic flooring.
 Revêtement acoustique.
 Akustikbelag.
 Pavimento acústico.

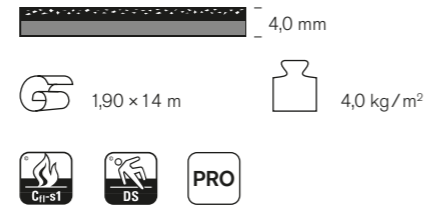

ZEUS / ANT 48*

Pavimento dissipativo. Superficie martellata multicolore.
 Dissipative flooring. Multicoloured tiles with a hammered surface.
 Revêtement de sol dissipateur. Dalles multicolores avec surface martelée.
 Ableitfähige Fußbodenbeläge. Mehrfarbige Fliesen mit Hammerschlagoberfläche.
 Pavimento disipativo. Baldosas multicolores con superficie martilleada

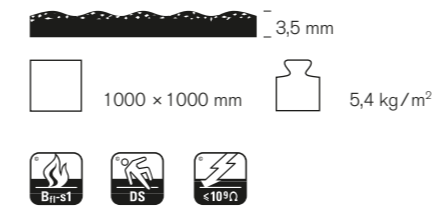

62



G 479

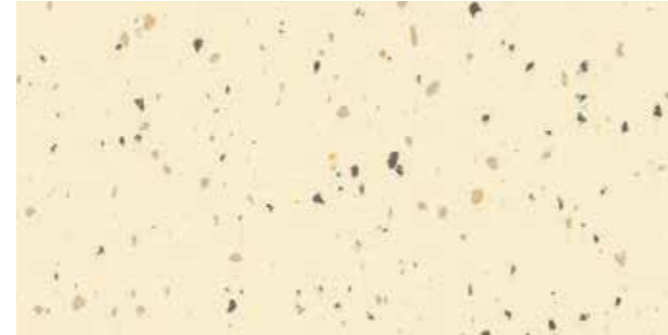

G 479

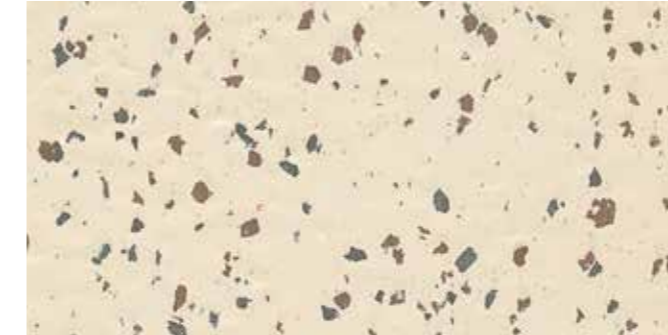

Z 630



G 480

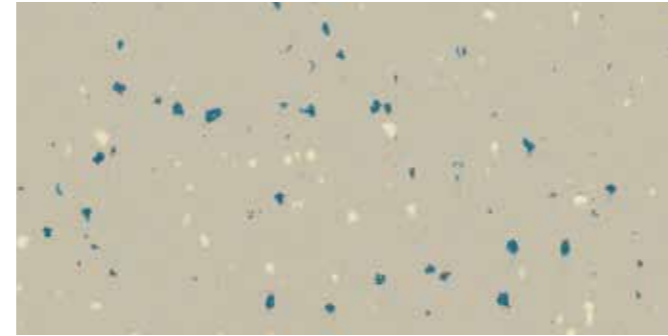

G 480

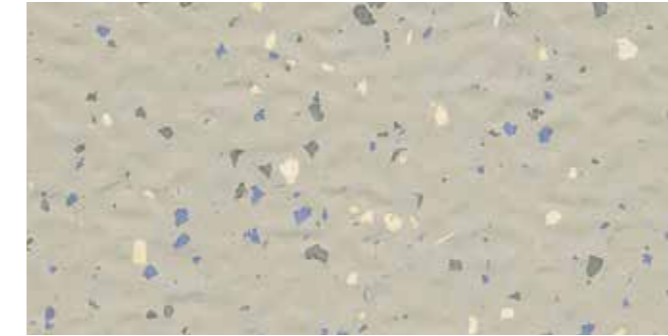

Z 642



G 305

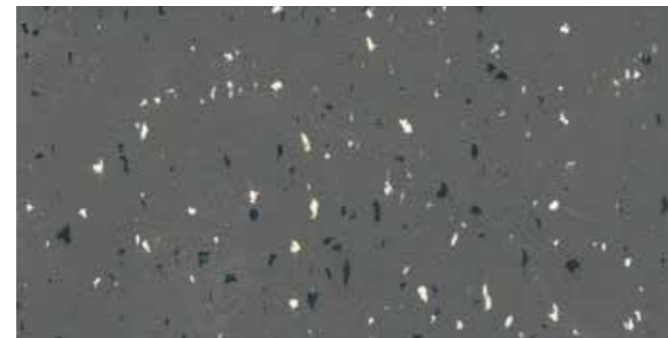

G 308

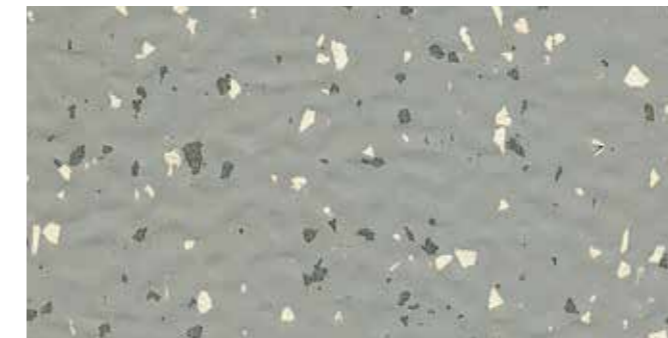

Z 626

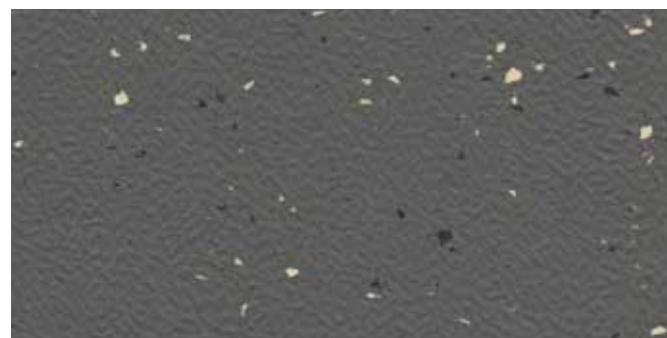

G 308



G 476

BS CLASSIC

I numeri in grassetto indicano la categoria di prezzo.
 The numbers in bold type indicate the price category.
 Les numéros en gras indiquent la catégorie de prix.
 Die fett gedruckten Zahlen geben die Preiskategorien an.
 Los números en negrita indican la categoría de precio.

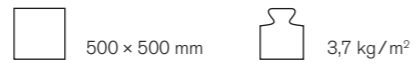

Classification UPEC **U₄ P₃ E₂ C_{1/2}**

BS STRONG•

Standard: N004, G847, G805, G804, G820, B207, R922.

Piastrelle monocore con rilievi a bolli.
 Solid colour round studded tiles.
 Dalles en teinte unie avec relief à pastille ronde.
 Einfarbige Fliesen mit Hohlkehrl-Rundnoppen.
 Baldosas monocolor con relieve de circulos con perfil redondeado.

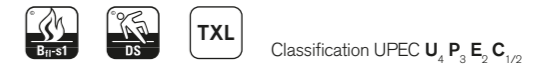
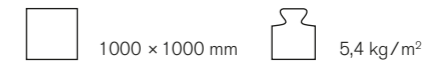

Classification UPEC **U₄ P₃ E₂ C_{1/2}**

64



V 713 Meadow **3**



V 755 Lime **3**



Y 507 Helios **3**



Y 510 Orange **3**



R 922 Love **3**•



G 814 Titanium **2**



G 815 Stone **2**



B 212 Sky **3**



B 218 Lagoon **3**



B 207 Jeans **2**•



G 816 Glacier **2**



G 810 Canvas **2**



G 811 Silver **2**



G 813 Falcon **2**



M 123 Brown **2**



G 820 Pearl **2**•



G 804 Metal **2**•



G 805 Eiffel **2**•



G 847 Slate **2**•



N 004 Carbon **1**•

65 Studsystem

ZEUS

Piastrelle multicolori con superficie martellata.
Multicoloured tiles with a hammered surface.
Dalles multicolores avec surface martelée.
Mehrfarbige Fliesen mit Hammerschlagoberfläche.
Baldosas multicolores con superficie martilleada.

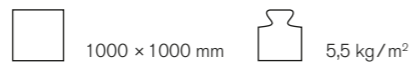

Classification UPEC U₄ P₃ E₂ C_{1/2}

66



Z 629

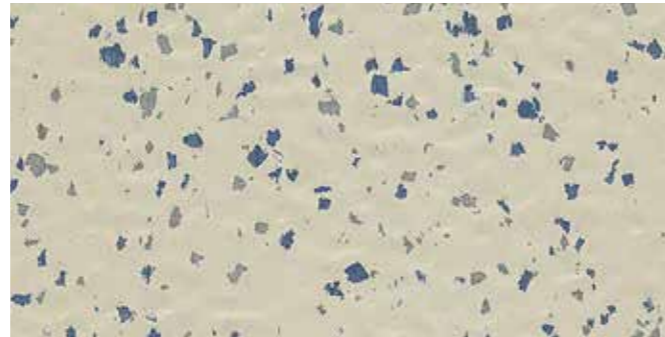

Z 640

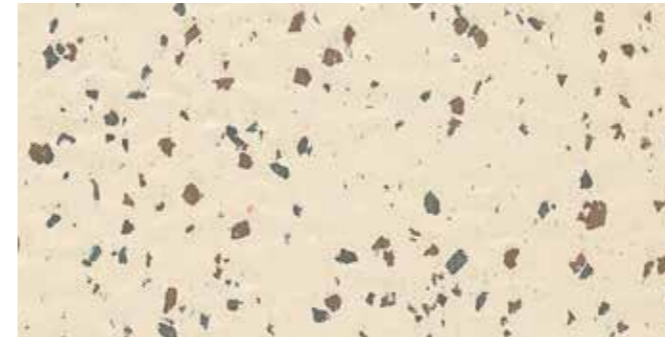

Z 630



Z 626

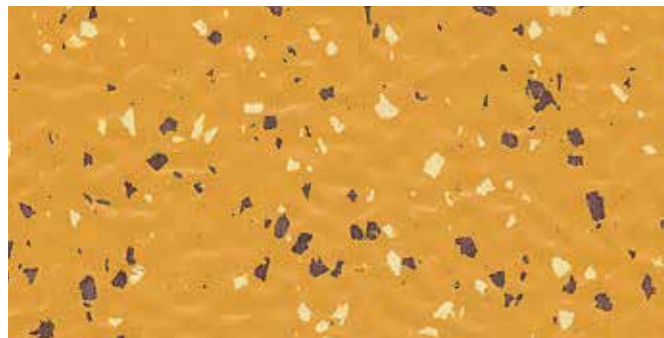

Z 637

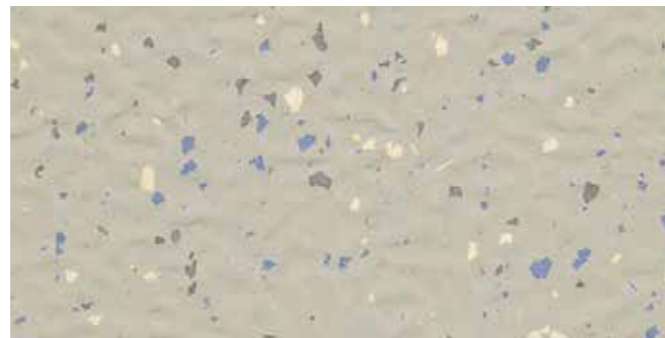

Z 642

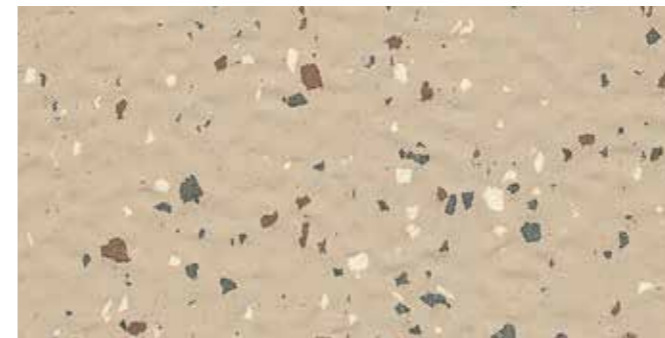

Z 628

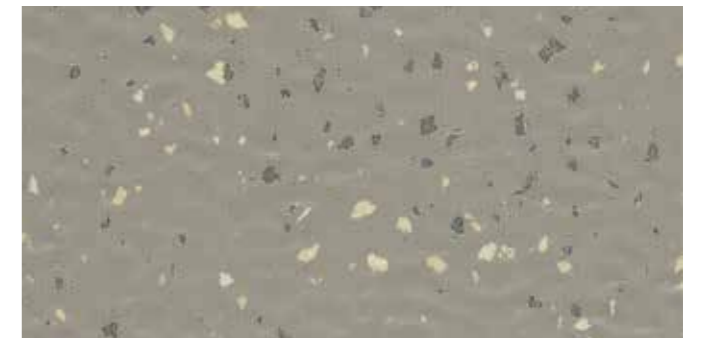

Z 639

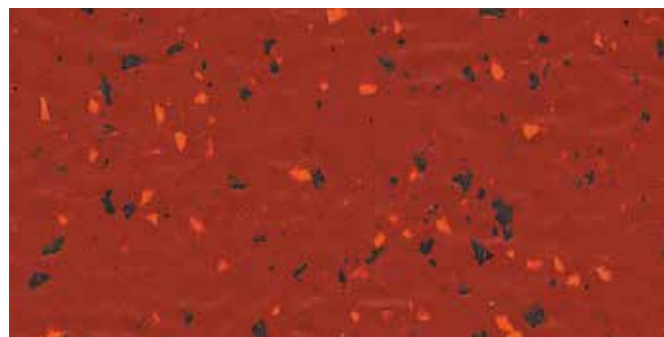

Z 631

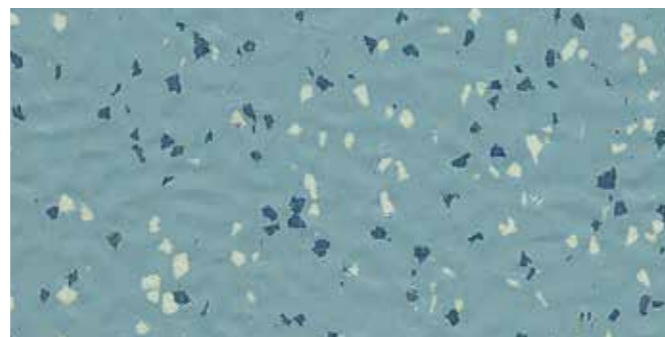

Z 635



Z 636

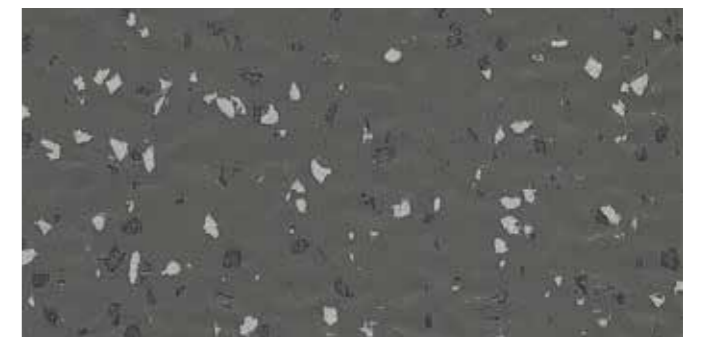

Z 638

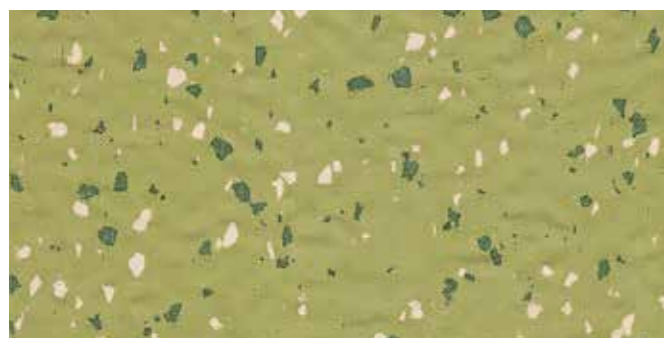

Z 634

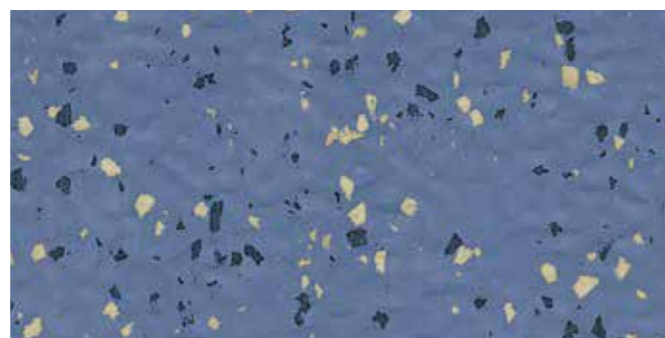

Z 632

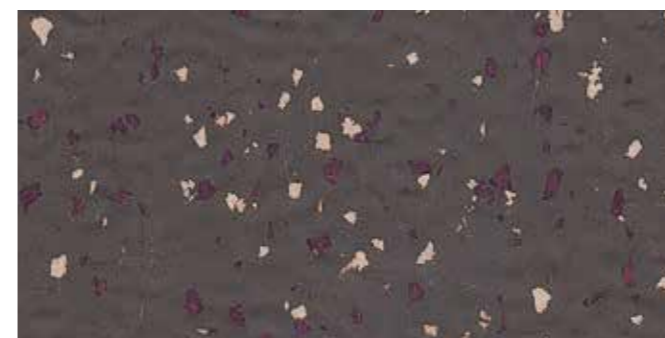

Z 633



Z 641

67

StudiSystem

FULLSTEP

Rivestimenti gradini a spigolo vivo. I numeri in grassetto indicano la categoria di prezzo.
 Square nosed step covering. The numbers in bold type indicate the price category.
 Marches integrales pour escalier à nez vif. Les numéros en gras indiquent la catégorie de prix.
 Beläge für stufen mit rechtwinkligen kanten. Die fett gedruckten Zahlen geben die Preiskategorien an.
 Revestimiento de peldaños con bordes vivos. Los números en negrita indican la categoría de precio.

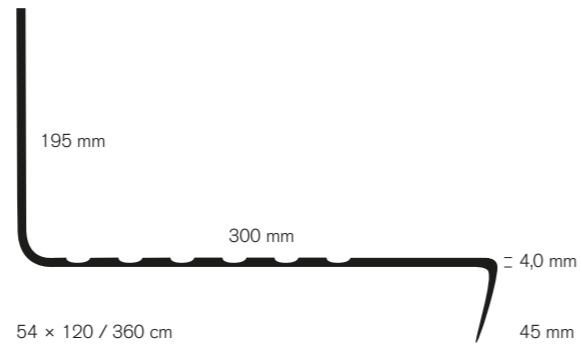

54 x 120 / 360 cm



BS R 922 3



BS G 847 2



BS N 004 1



BS G 820 2



BS G 804 2



BS G 805 2

ROLLSTEP

Rivestimenti gradini a spigolo arrotondato. I numeri in grassetto indicano la categoria di prezzo.
 Round nosed step covering. The numbers in bold type indicate the price category.
 Marches integrales pour escaliers à nez arrondi. Les numéros en gras indiquent la catégorie de prix.
 Beläge für stufen mit gerundeten kanten. Die fett gedruckten Zahlen geben die Preiskategorien an.
 Revestimiento de peldaños con bordes redondeados. Los números en negrita indican la categoría de precio.

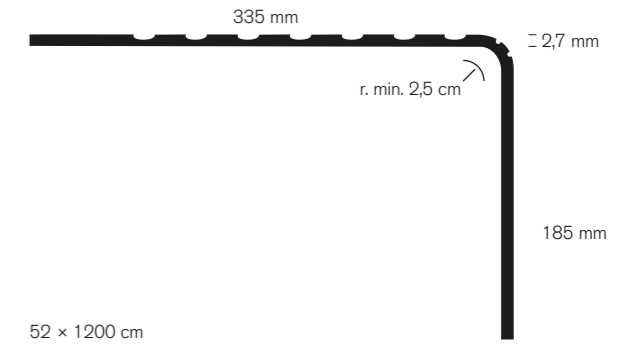

52 x 1200 cm



BS R 922 3



BS G 847 2



BS N 004 1



BS G 820 2



BS G 804 2



BS G 805 2

SN 001 – 002

Profili in gomma per gradini a spigolo vivo.
Rubber profiles for sharp-edged steps.
Profils en caoutchouc pour marches à arête vive.
Kautschukprofile zur Verkleidung von scharfkantigen Stufen.
Perfiles en goma para peldaños de arista viva.

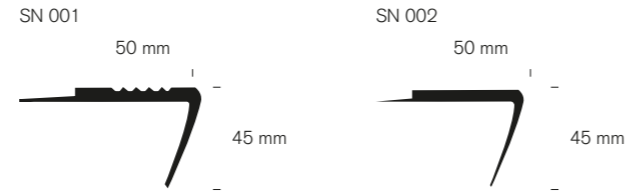

70



Y 507



G 804



G 805



N 004

SNA

Profili in alluminio per gradini a spigolo vivo.
Aluminium profiles for sharp-edged steps.
Profils aluminium pour nez de marche à arête vive.
Aluminiumprofile zur Verkleidung von scharfkantigen Stufen.
Perfiles de aluminio para de peldaños de arista viva.

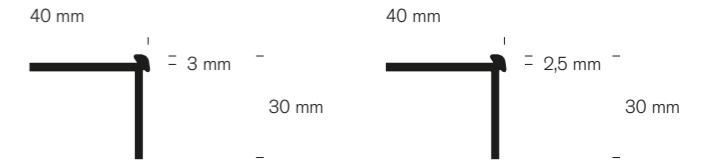

SILVER

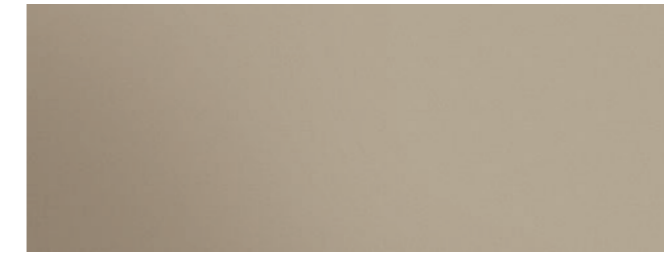

TITAN

71

SKI 60 – SKI 100

Profili in gomma per battiscopa.
 Rubber profiles for skirtings.
 Profils en caoutchouc pour plinthes.
 Kautschukprofile für Sockelleisten
 Perfil de goma para zócalos.

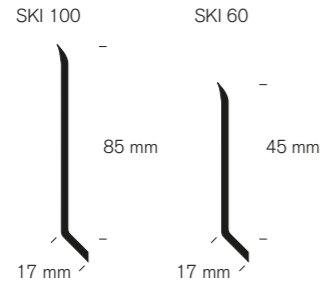

PS 25

Profilo per sguscia.
 Cove former.
 Profilés pour remontée.
 Hohlkehprofil.
 Perfil de salida.



SA

Profili per scale.
 Stair profiles.
 Plinthes pour escalier.
 Treppenwinkel.
 Perfiles para escaleras.

SA 400/1 – SA 500/1

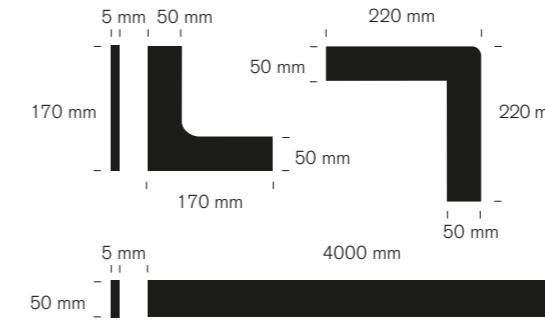

SA 200/E – SA 300/E

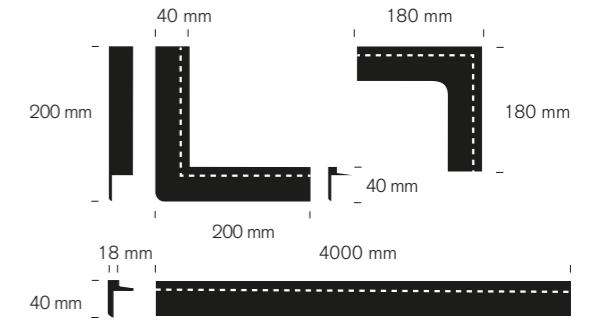

72



B 207



G 820



G 804



G 805

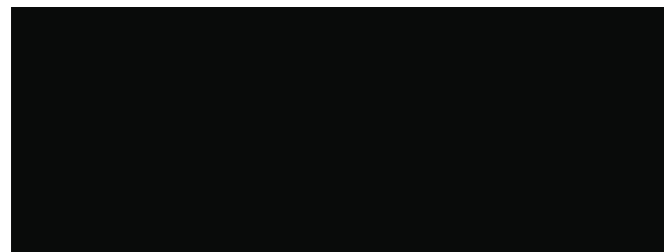

N 004



N 004



G 804



G 805



N 004

73

Legenda simboli
Key to symbols
Légende symboles
Erklärung der Symbole
Leyenda símbolos



Resistenza allo scivolamento
 Slip resistance
 Résistance au glissement
 Rutschhemmung
 Resistencia al deslizamiento

Legenda trattamenti
Key to treatments
Légende
Erklärung Oberflächenausführung
Leyenda de los tratamientos

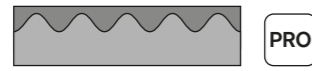

DHARMA
GRAIN
GRANITO
KAYAR
KAYAR LL
NATURA
SCREED
MULTIFLOOR / ND – UNI
UNI LL
X - ELASTIC

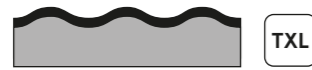

BS CLASSIC
BS STRONG
LAVA
ZEUS

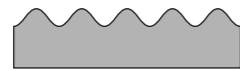

Standard
GRANITO ANT48
ZEUS ANT48



Alto contenuto ecologico
 High ecological content
 Contenu écologique élevé
 Alto contenido ecológico
 Hoher ökologischer Gehalt
SCREED



Resistenza scivolamento DIN 51130
 Slip resistance DIN 51130
 Résistance au glissement DIN 51130
 Rutschhemmung DIN 51130
 Resistencia al deslizamiento DIN 51130
LAVA

74



Euroclasse di reazione al fuoco
 Euro class of fire reaction
 Euro class de comportement au feu
 Brandverhalten Euroklasse
 Euroclase de reacción al fuego



Antistatico
 Antistatic
 Antistatique
 Antistatisch
 Antiestático

Finitura PRO
PRO finish
Finition PRO
PRO Oberflächenvergütung
Acabado PRO

Trattamento superficiale realizzato tramite spalmatura di coating polimerico di ultima generazione fissato con reticolazione UV. La copertura polimerica protegge la superficie migliorandone le performance riducendo gli interventi di pulizia e manutenzione.

A surface treatment utilising the latest generation UV linked polymeric coating technology. The coating finish protects the surface, improves performance and reduces the need for cleaning and maintenance.

Traitement de la surface réalisé par enduisage d'un coating de polymères de la dernière génération fixé avec réticulation UV. La couverture polymérique protège la surface, en améliorant les performances et en réduisant les opérations de nettoyage et entretien.

Oberflächenbehandlung, bei der eine Polymervergütung der letzten Generation aufgebracht und UV- vernetzt wird. Die Vergütung schützt die Oberfläche, verbessert die Widerstandsfähigkeit und reduziert Pflege- und Reinigungskosten.

Tratamiento superficial realizado a través de la aplicación del coating polimérico de última generación fijado con reticulación UV. La cobertura polimérica protege la superficie mejorando la performance reduciendo las operaciones de limpieza y manutención.

Vantaggi del trattamento PRO rispetto al pavimento tradizionale

- Ottima protezione da sporco e graffi
- Migliore resistenza a macchie ed agenti chimici
- Non è necessaria la ceratura (ad eccezione delle aree ad alto traffico, come ulteriore protezione)
- Facilità di pulizia e manutenzione
- Risparmio di acqua, detersivi ed energia
- Ottimo impatto economico sul ciclo di vita del prodotto
- Ridotta emissione di TVOC

Advantages of PRO treatment compared with standard flooring

- High protection against dirt and scratches
- Enhanced resistance to stains and chemical agents
- No further wax/polishing necessary (except for added protection in very high traffic areas)
- Easier cleaning and maintenance
- Saving in water, detergents and energy
- Excellent economical impact on lifecycle cost
- Lower TVOC emission

Avantages du traitement PRO par rapport au sol traditionnel

- Excellente protection de la saleté et des égratignures
- Résistance meilleure aux taches et aux agents chimiques
- Pas de cirage (à l'exception de zones à passage intense comme ultérieur protection)
- Facilité de nettoyage et entretien
- Economie d'eau, détergents et énergie
- Excellent résultat économique sur le cycle vital du produit
- Emissions réduites d'après TVOC test

Vorteile der PRO Oberflächenvergütung im Vergleich mit Standardbodenbelägen

- Hoher Schutz gegen Schmutz und Zerkratzungen
- Bessere Widerstandsfähigkeit gegen Flecken und chemische Substanzen
- Einlassen ist nicht notwendig (nur zum zusätzlicher Schutz in extrem beanspruchten Bereichen)
- Leichtere Reinigung und Pflege
- Einsparung von Wasser, Reinigungsmittel und Energie
- Kosteneinsparung über den gesamten Lebenszyklus des Bodenbelags
- Geringere Emission von flüchtigen organischen Verbindungen (VOC)

Ventajas del tratamiento PRO respecto al pavimento tradicional

- Óptima protección de la suciedad y rasguños
- Mejor resistencia a las manchas y agentes químicos
- No es necesario el encerado (excepto en zonas de alto tráfico, como ulterior protección)
- Facilidad de limpieza y manutención
- Ahorro de agua, detergentes y energía
- Óptimo impacto económico en el ciclo de vida del producto
- Reducida emisión de TVOC

Finitura TXL
TXL finish
Finition TXL
TXL Oberflächenverdichtung
Acabado TXL

Trattamento superficiale di postvulcanizzazione che incrementa la resistenza e densità superficiale. La minor porosità della superficie ne migliora la pulibilità e la resistenza allo sporco.

Post vulcanization treatment that achieves a lower surface density whilst increasing surface resistance, enhancing cleaning, dirt and scratch resistant properties.

Traitement superficiel de post vulcanisation qui augmente la résistance et la densité de la surface. La moindre porosité de la surface améliore le nettoyage et la résistance à la saleté.

Postvulkanisationsbehandlung, welche die Dichte und Widerstandsfähigkeit der Oberfläche erhöht. Eine niedrigere Oberflächenporosität verbessert Reinigungs- und Anschnutzverhalten.

Tratamiento superficial de postvulcanización que incrementa la resistencia y densidad superficial. La menor porosidad de la superficie mejora la limpieza y la resistencia a la suciedad.

Vantaggi del trattamento TXL rispetto al pavimento tradizionale

- Maggiore protezione da sporco e graffi
- Non è necessaria la ceratura per applicazioni soggette a manutenzione regolare con utilizzo di monospazzola
- Facilità di pulizia e manutenzione
- Risparmio di acqua, detersivi ed energia
- Buon impatto economico sul ciclo di vita del prodotto

Advantages of TXL treatment compared with standard flooring

- Enhanced protection against dirt and scratches
- No further wax/polishing necessary in low traffic areas
- Easier cleaning and maintenance
- Saving in water, detergents and energy
- Appreciable economical impact on lifecycle cost.

Avantages du traitement TXL par rapport au sol traditionnel

- Protection meilleure de la saleté et des égratignures
- Cirage non pas nécessaire en cas d'entretien régulier avec mono brosse.
- Facilité de nettoyage et entretien
- Economie d'eau, détergents et énergie
- Excellent résultat économique su le cycle vital du produit

Vorteile der TXL Oberflächenverdichtung im Vergleich mit Standardbodenbelägen

- Besserer Schutz gegen Schmutz und Zerkratzungen
- Einlassen ist in Bereichen mit niedriger Frequenz nicht notwendig, wenn mit Einscheibenmaschinen u. ähnliches regelmäßig gereinigt wird
- Leichtere Reinigung und Pflege
- Einsparung von Wasser, Reinigungsmittel und Energie
- Merkbare Kostenersparnis über den gesamten Lebenszyklus des Bodenbelags

Ventajas del tratamiento TXL respecto al pavimento tradicional

- Mayor protección a la suciedad y a los rasguños
- No es necesario el encerado para aplicaciones sometidas a manutención regular de utilización de mono-escoba
- Facilidad de limpieza y manutención
- Ahorro de agua, detergentes y energía
- Buen impacto económico sobre el ciclo de vida del producto

75

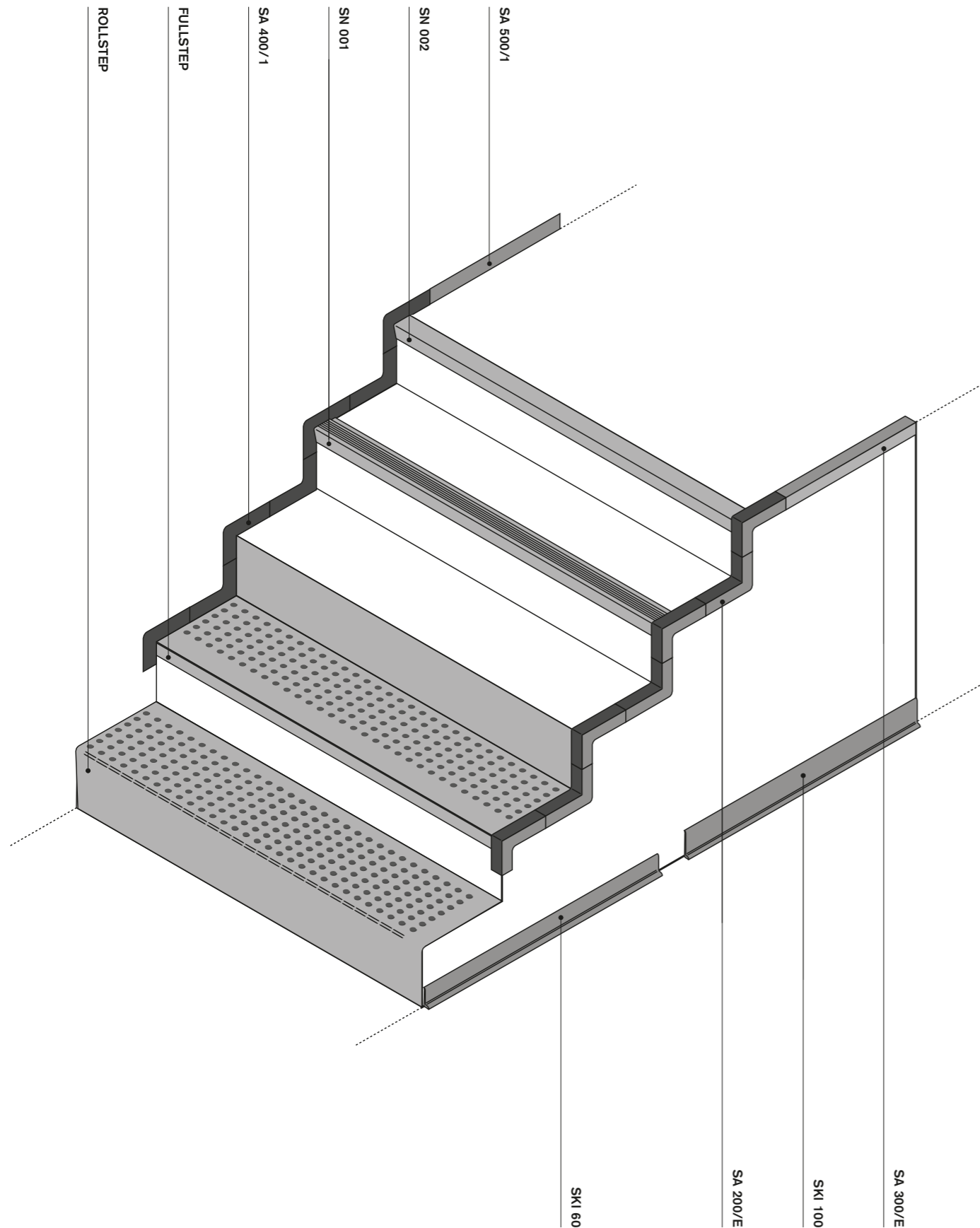

FULLSTEP

Rivestimenti gradini a spigolo vivo. Rivestimento gradino costituito da pedata con rilievo a bolli bassi, paraspigolo e alzata liscia in un sol pezzo.
 Square nosed step covering. One-piece step covering with studded tread, smooth nosing and riser.
 Marches intégrales pour escalier à nez vif. Marche intégrale constituée d'une marche avec relief à pastille basse, nez de marche et contremarche lisse dans une seule pièce.
 Beläge für stufen mit rechtwinkligen kanten. Einteiliges Formtreppenteil, mit genopptem Trittstufenteil, Treppenkante und glatter Setzstufe.
 Revestimiento de peldaños con bordes vivos. Revestimiento de peldaño formado por peldaño en relieve a círculos bajos, moldura y contrapeldaño en una sola pieza.

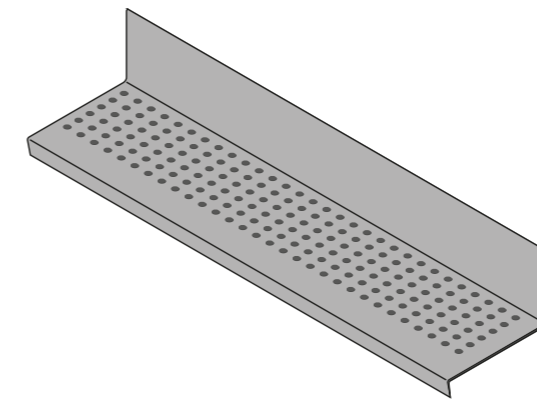

ROLLSTEP

Rivestimenti gradini a spigolo arrotondato. Rivestimento gradino costituito da pedata con rilievo a bolli bassi, paraspigolo con rigature trasversali e alzata liscia.
 Round nosed step covering. Step covering in rolls (12 m) with a low studded tread ribbed nosing and smooth riser.
 Marches intégrales pour escaliers à nez arrondi. Marche intégrale en rouleaux constituée d'une marche avec relief à pastille basse, de nez de marche cannelé et de contremarche lisse.
 Beläge für stufen mit gerundeten kanten. Rollen- Formtreppenstufen: Trittstufe mit Rundnoppen, gerippten Treppenkanten mit geringem Verschnitt und glatter Setzstufe.
 Revestimiento de peldaños con bordes redondeados. Revestimiento de peldaños formado por el peldaño con relieve a círculos bajos, moldura con estrias trasversales y contrapeldaño liso.

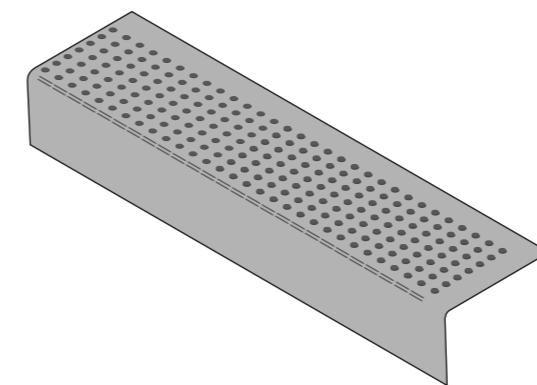

SA 500/I

Battiscopa interno per pianerottolo
 Internal skirting for landing
 Plinthe intérieure pour palier
 Podestleiste wandseitig
 Zócalo interior para rellanos

SN 002

Paragradino liscio per gradini a spigolo vivo
 Smooth stair nosing for square nosed steps
 Nez de marches lisses pour marches à nez vif
 Treppenkante glatt (für scharfkantige Stufen)
 Moldura lisa para peldaños con bordes vivos

SN 001

Paragradino rigato per gradini a spigolo vivo
 Ribbed stair nosing for square nosed steps
 Nez de marches striés pour marches à nez vif
 Treppenkante gerillt (für scharfkantige Stufen)
 Moldura con estrias para peldaños con bordes vivos

SA 400/I

Angolari interni per gradini a spigolo vivo
 Internal stair angles for square nosed steps
 Angles intérieurs d'escaliers à nez vif pour paliers
 Treppenwinkel wandseitig (für scharfkantige Stufen)
 Angulares interiores para peldaños con bordes vivos

SA 300/E

Battiscopa esterno per pianerottolo
 External skirting for landing
 Plinthe extérieure pour palier
 Podestleiste aussen
 Zócalo exterior para rellanos

SA 200/E

Angolari esterni per gradini a spigolo vivo
 External stair angles for square nosed steps
 Angles extérieurs d'escalier à nez vif pour palier
 Treppenwinkel aussen (für scharfkantige Stufen)
 Angulares exteriores para peldaños con bordes vivos

SKI 100

Battiscopa altezza ca. 100 mm
 Skirting ca. 100 mm in height
 Plinthe hauteur ca. 100 mm
 Sockelleiste ca. 100 mm hoch
 Zócalo de ca. 100 mm de altura

SKI 60

Battiscopa altezza ca. 60 mm
 Skirting ca. 60 mm in height
 Plinthe hauteur ca. 60 mm
 Sockelleiste ca. 60 mm hoch
 Zócalo de ca. 60 mm de altura

Plansystem

Caratteristiche Characteristics Caractéristiques Eigenschaften Características	Norma Standard Norme Norma	U. di misura Unit Unité Masseinheit Unidad	Requisiti Requirements Exigences Anforderung Valores	DHARMA	KAYAR ND /UNI NATURA	GRAIN SCREED	GRANITO	GRANITO ANT 48	X-Elastic versions
Durezza Hardness Dureté Härte Dureza	ISO 7619	Shore A	≥ 75	85	90 85 88	90	90	85	88 84 (Dharma)
Impronta residua Residual indentation Poinçonnement rémanent Resteindruck Punzonamiento residual	EN 433	mm	≤ 0,15 ≤ 0,20 ≤ 0,25	0,03	– 0,08 –	– 0,08 –	0,05 – –	0,08 – –	– – 0,20
Resistenza all'abrasione Abrasion resistance Résistance à l'abrasion Abriebfestigkeit Resistencia a la abrasión	ISO 4649 (Met. A–5N)	mm ²	≤ 250	130	190 165 145	160 165	150	160	Kayar 190 Nd/Uni 165 Natura 145 Grain 160 Screed 165 Granito 150 Lava 150 Dharma 130
Stabilità dimensionale Dimensional stability Stabilité dimensionnelle Maßbeständigkeit Estabilidad dimensional	EN 434	%	± 0,40 max	± 0,30	± 0,30				
Flessibilità Flexibility Flexibilité Biegsamkeit Flexibilidad	EN 435 Met. A (Ø 20 mm)		Nessuna fessurazione No fissuring Pas de fissuration Keine Ribbildung Ninguna fisura	Conforme Comply	Conforme Comply				
Solidità del colore alla luce artificiale Colour fastness to artificial light Essais de tenue des couleurs à la lumière artificielle Farbbeständigkeit gegenüber künstlichem Licht geeignet Solidez del color a la luz artificial	ISO 105–B02 Met. 3	Grado Degree Degré Stufe	≥ 6 scala blu ≥ 6 blue scale ≥ 6 échelle bleu ≥ 6 Blaumaßstabs ≥ 6 escala azules	≥ 3 scala grigi ≥ 3 grey scale ≥ 3 échelle gris ≥ 3 Graumaßstabs ≥ 3 escala grises	Conforme Comply	Conforme Comply			
Effetto bruciatura sigaretta Cigarette burn Résistance aux cigarettes incandescentes Einwirkung glimmender Tabakwaren Efecto quemadura cigarrillos	EN 1399	Rating Stufe	Met. A ≥ 4 Met. B ≥ 3	Conforme Comply	Conforme Comply				
Reazione al fuoco Fire behaviour Comportement au feu Brandverhalten Reacción al fuego	EN 13501–1	Classe Class Clase Klasse		Bfl–s1	Bfl–s1 Kayar Nd/Uni Cfl–s1 Natura	Bfl–s1 Grain Cfl–s1 Screed	Bfl–s1	Bfl–s1	Cfl–s1
Resistenza allo scivolamento Slip resistance Résistance au glissement Rutschhemmung Resistencia al deslizamiento	EN 13893	Classe Class Clase Klasse	≥ 0,30 (DS)	≥ 0,30	≥ 0,30				
Resistenza alle macchie Resistance to stains Résistance aux taches Chemikalienbeständigkeit Resistencia a las manchas	EN 423			Resistente ⁽¹⁾ Resistent ⁽¹⁾ Résistant ⁽¹⁾ Beständig ⁽¹⁾	Resistente ⁽¹⁾ Resistent ⁽¹⁾ Résistant ⁽¹⁾ Beständig ⁽¹⁾				
Carica elettrostatica da calpestio Electrostatic charge Charge électrostatique à la marche Elektrostatisches Verhalten beim Begehen Carga electrostática a la pisada	EN 1815	kV		≤ 2	≤ 2				
Riduzione del rumore da calpestio Reduction of sound due to treading Insolation acoustique à la marche Trittschallverbesserungsmaß Reducción del ruido a la pisada	ISO 10140–3	dB	Fino a Up to	6	10	10	6	6	20
Effetto sedia a rotelle Castor chairs L'action d'une chaise à roulettes Stuhlrollenversuch Efecto de las sillas de ruedas	EN 425				Adatto con ruote tipo W Suitable for W castors Convient aux chaises à roulettes type W Geeignet für Rollen Typ W Adecuado con ruedas tipo W				
Comportamento elettrico Electrical behaviour Comportement électrique Erdableitwiderstand Comportamiento eléctrico	EN 1081	ohm	Ant 48: Rv ≤ 10 ⁹ static dissipative					≤ 10 ⁹	

⁽¹⁾ In base a concentrazione e tempo di contatto, per agenti specifici inoltrare richiesta.
Depending on concentration and time of contact, for specific agents please ask.
Dépend du produit de sa concentration et de sa durée de contact avec le revêtement. Pour plus d'informations contactez nos services techniques.
Abhängig von Konzentration und Einwirkzeit, bei speziellen Chemikalien ist Rücksprache erforderlich.
En función a la concentración y el tiempo de contacto, consultar para productos específicos.

Studsystem

Caratteristiche Characteristics Caractéristiques Eigenschaften Características	Norma Standard Norme Norma	U. di misura Unit Unité Masseinheit Unidad	Requisiti Requirements Exigences Anforderung Valores	UNI LL KAYAR LL	BS– CLASSIC STRONG	LAVA	ZEUS	ZEUS ANT 48
Durezza Hardness Dureté Härte Dureza	ISO 7619	Shore A	≥ 70 ≥ 75	86	90	90	90	85
Impronta residua Residual indentation poinçonnement rémanent Resteindruck Punzonamiento residual	EN 433	mm	≤ 0,20 ≤ 0,25	≤ 0,20	0,08 0,12	0,09 –	– 0,10	– 0,15
Resistenza all'abrasione Abrasion resistance Résistance à l'abrasion Abriebfestigkeit Resistencia a la abrasión	ISO 4649 (Met. A–5N)	mm ²	≤ 250	190 150	160	150	140	160
Stabilità dimensionale Dimensional stability Stabilité dimensionnelle Maßbeständigkeit Estabilidad dimensional	EN 434	%	± 0,40 max	± 0,30				
Flessibilità Flexibility Flexibilité Biegsamkeit Flexibilidad	EN 435 Met. A (Ø 20 mm)		Nessuna fessurazione No fissuring Pas de fissuration Keine Ribbildung Ninguna fisura	Conforme Comply				
Solidità del colore alla luce artificiale Colour fastness to artificial light Essais de tenue des couleurs à la lumière artificielle Farbbeständigkeit gegenüber künstlichem Licht Solidez del color a la luz artificial	ISO 105–B02 Met. 3	Grado Degree Degré Stufe	≥ 6 scala blu ≥ 6 blue scale ≥ 6 échelle bleu ≥ 6 Blaumaßstabs ≥ 6 escala azules	≥ 3 scala grigi ≥ 3 grey scale ≥ 3 échelle gris ≥ 3 Graumaßstabs ≥ 3 escala grises	Conforme Comply			
Effetto bruciatura sigaretta Cigarette burn Résistance aux cigarettes incandescentes Einwirkung glimmender Tabakwaren Efecto quemadura cigarrillos	EN 1399	Rating Stufe	Met. A ≥ 4 Met. B ≥ 3	Conforme Comply				
Reazione al fuoco Fire behaviour Comportement au feu Brandverhalten Reacción al fuego	EN 13501–1	Classe Class Clase Klasse		Bfl–s1	Bfl–s1	Bfl–s1	Bfl–s1	Bfl–s1
Resistenza allo scivolamento Slip resistance Résistance au glissement Rutschhemmung Resistencia al deslizamiento	EN 13893	Classe Class Clase Klasse	≥ 0,30 (DS)	≥ 0,30				
Resistenza alle macchie Resistance to stains Résistance aux taches Chemikalienbeständigkeit Resistencia a las manchas	EN 423			Resistente ⁽¹⁾ Resistent ⁽¹⁾ Résistant ⁽¹⁾ Beständig ⁽¹⁾	Resistente ⁽¹⁾ Resistent ⁽¹⁾ Résistant ⁽¹⁾ Beständig ⁽¹⁾			
Carica elettrostatica da calpestio Electrostatic charge Charge électrostatique à la marche Elektrostatisches Verhalten beim Begehen Carga electrostática a la pisada	EN 1815	kV		≤ 2				
Riduzione del rumore da calpestio Reduction of sound due to treading Insolation acoustique à la marche Trittschallverbesserungsmaß Reducción del ruido a la pisada	ISO 10140–3	dB	Fino a Up to	16	8 10	10	12	12
Effetto sedia a rotelle Castor chairs L'action d'une chaise à roulettes Stuhlrollenversuch Efecto de las sillas de ruedas	EN 425				Adatto con ruote tipo W Suitable for W castors Convient aux chaises à roulettes type W Geeignet für Rollen Typ W Adecuado con ruedas tipo W			
Comportamento elettrico Electrical behaviour Comportement électrique Erdableitwiderstand Comportamiento eléctrico	EN 1081 Met. A	ohm	Ant 48: Rv ≤ 10 ⁹ static dissipative					≤ 10 ⁹

⁽¹⁾ In base a concentrazione e tempo di contatto, per agenti specifici inoltrare richiesta.
Depending on concentration and time of contact, for specific agents please ask.
Dépend du produit de sa concentration et de sa durée de contact avec le revêtement. Pour plus d'informations contactez nos services techniques.
Abhängig von Konzentration und Einwirkzeit, bei speziellen Chemikalien ist Rücksprache erforderlich.
En función a la concentración y el tiempo de contacto, consultar para productos específicos.

Artigo Spa

Via Cascina Vione 3
20080 Basiglio (Mi), Italy
Tel +39 0290786415
Fax +39 0290786449

Artigo France Sarl

24, rue Firmin Gillot
75015 Paris, France
Tel +33 0142770000

Artigo Iberica SL

Profesor Beltran Baguena 4
46009 Valencia, Spain
Tel +34 963498899
Fax +39 963498713

www.artigo.com

80

Graphic design and illustrations: Juma
Technical photos: F2 Fotografia
Prepress: Diodo
Printing: Optima

Printed in Italy, December 2019

I dati tecnici riportati in questo catalogo possono essere soggetti a modifiche senza preavviso.

The technical details shown in this catalogue are subject to change without notice.

Les données techniques figurant dans ce catalogue peuvent être sujettes à modifications sans avis préalable.

Die in diesem Katalog wiedergegebenen technischen Daten können ohne Vorankündigung verändert werden.

Los datos técnicos indicados en este catálogo pueden ser modificados sin aviso previo.

